

Functional Mock-up Interface for Model Exchange

MODELISAR (07006)

Document version: 1.0
January 26, 2010

.....



History

Version	Date	Remarks
1.0	2010-01-26	First version

License of this document

Copyright © 2008-2010, MODELISAR consortium.

This document is provided “as is” without any warranty. It is licensed under the CC-BY-SA (Creative Commons Attribution-Sharealike 3.0 Unported) license, i.e., the license used by Wikipedia. Human-readable summary of the license text from <http://creativecommons.org/licenses/by-sa/3.0/>:

You are free:

- **to Share** — to copy, distribute and transmit the work, and
- **to Remix** — to adapt the work

Under the following conditions:

- **Attribution** — You must attribute the work in the manner specified by the author or licensor (but not in any way that suggests that they endorse you or your use of the work.)
- **Share Alike** — If you alter, transform, or build upon this work, you may distribute the resulting work only under the same, similar or a compatible license.

The legal license text and disclaimer is available at:

<http://creativecommons.org/licenses/by-sa/3.0/legalcode>

Note:

- Article (3a) of this license requires that modifications of this work must clearly label, demarcate or otherwise identify that changes were made.
- The C-header and XML-schema files that accompany this document are available under the BSD license (<http://www.opensource.org/licenses/bsd-license.html>) with the extension that modifications must be also provided under the BSD license.
- If you have improvement suggestions, please send them to the FMI development group at info@functional-mockup-interface.org.

Abstract

This document defines the “Functional Mock-up Interface for Model Exchange”. The intention is that a modelling environment can generate C-Code of a dynamic system model that can be utilized by other modelling and simulation environments. Models are described by differential, algebraic and discrete equations with time-, state- and step-events. The models to be treated by this interface can be large for usage in offline or online simulation or can be used in embedded control systems on micro-processors. It is possible to utilize several instances of a model and to connect models hierarchically together. A model is independent of the target simulator because it does not use a simulator specific header file as in other approaches.

A model is distributed in one zip-file that contains several files:

- (1) An xml-file contains the definition of all variables in the model and other model information. It is then possible to run the model on a target system without this information, i.e., with no unnecessary overhead.
- (2) All needed model equations are provided with a small set of easy to use C-functions. A new caching technique allows a more efficient evaluation of the model equations as in other approaches. These C-functions can either be provided in source and/or binary form. Binary forms for different platforms can be included in the same model zip-file.
- (3) Further data can be included in the zip-file, especially a model icon (bitmap file), documentation files, maps and tables needed by the model, and/or all object libraries or DLLs that are utilized.



Contents

1. Overview	5
1.1. <i>Properties and Guiding Ideas</i>	6
1.2. <i>Acknowledgements</i>	8
2. Model Interface	9
2.1. <i>Mathematical Description</i>	9
2.2. <i>Platform Dependent Definitions (fmiModelTypes.h)</i>	12
2.3. <i>Status Returned by Functions</i>	14
2.4. <i>Inquire Platform and Version Number of Header Files</i>	14
2.5. <i>Creation and Destruction of Model Instances</i>	15
2.6. <i>Providing Independent Variables and Re-initialization of Caching</i>	16
2.7. <i>Evaluation of Model Equations</i>	18
2.8. <i>External Models</i>	21
2.9. <i>State Machine of Calling Sequence</i>	22
2.10. <i>Example</i>	23
3. Model Description Schema	26
3.1. <i>Description of a Model (fmiModelDescription)</i>	27
3.2. <i>Definition of a Type (fmiType)</i>	31
3.3. <i>Definition of a Scalar Variable (fmiScalarVariable)</i>	33
3.4. <i>Example</i>	38
4. Model Distribution	40
5. Literature	42
Appendix A Contributors	43
A.1 <i>Version 1.0</i>	43
Appendix B Implementation Issues	44
B.1 <i>Variable Naming Conventions</i>	44
B.2 <i>Event Detection</i>	45
B.3 <i>Dynamic State Selection</i>	47
B.4 <i>Variable Caching</i>	47
B.5 <i>Connecting FMUs together</i>	48
Appendix C Features for Future Versions	52
Appendix D Glossary	55

1. Overview

The FMI (Functional Mock-up Interface) defines an interface to be implemented by an executable called FMU (Functional Mock-up Unit). The FMI functions are used (called) by a simulator to create one or more instances of the FMU, called models, and to run these models, typically together with other models. An FMU may either be self-integrating (co-simulation) or require the simulator to perform numerical integration. In this document, the interface for the latter case is defined¹.

The goal is to describe models of dynamic systems, i.e., models defined by differential, algebraic and discrete equations and to provide an interface to evaluate these equations as needed in different simulation environments, as well as in embedded control systems, with explicit or implicit integrators and fixed or variable step-size. The interface is designed so that large models can be described and consists of the following parts:

- Model Interface
All needed equations are evaluated by calling standardized "C" functions. "C" is used, because it is the most portable programming language today and is the only programming language that can be utilized in all embedded control systems.
- Model Description Schema
The schema defines the structure and content of an xml-file generated by a modelling environment. This xml-file contains the definition of all variables in the model in a standardized way. It is then possible to run the C-code in an embedded system without the overhead of the variable definition (the alternative would be to store this information in the C-code and access it via function calls, but this is not practical for embedded systems and not for large models). Furthermore, the variable definition is a complex data structure and tools should be free how to represent this data structure in their programs. The selected approach allows a tool to store and access the variable definitions (without any memory or efficiency overhead of standardized access functions) in the programming language of the simulation environment, usually C++, C# or Java. Note, there are many free and commercial libraries in different programming languages to read xml-files in to an appropriate data structure, see, e.g., <http://en.wikipedia.org/wiki/Xml#Parsers>.

A model is distributed in one zip-file. The zip-file contains (more details are given in section 4):

- The Model Description File (xml format).
- The C sources of the Model Interface (including the needed run-time libraries used in the model) and/or
Dynamic link libraries (DLL) for one or several target machines. This solution is especially used, if the model provider wants to hide the model source code to secure the contained know-how. A model may contain physical parameters or geometrical dimensions, which should not be open. On the other hand, some functionality requires source code.
- Additional model data (like tables, maps) in model specific file formats.

A schematic view of a model in "FMI for Model Exchange" format is shown in the next figure:

¹ A simple form of co-simulation is also possible with this interface, by treating a co-simulated model as a discrete system.

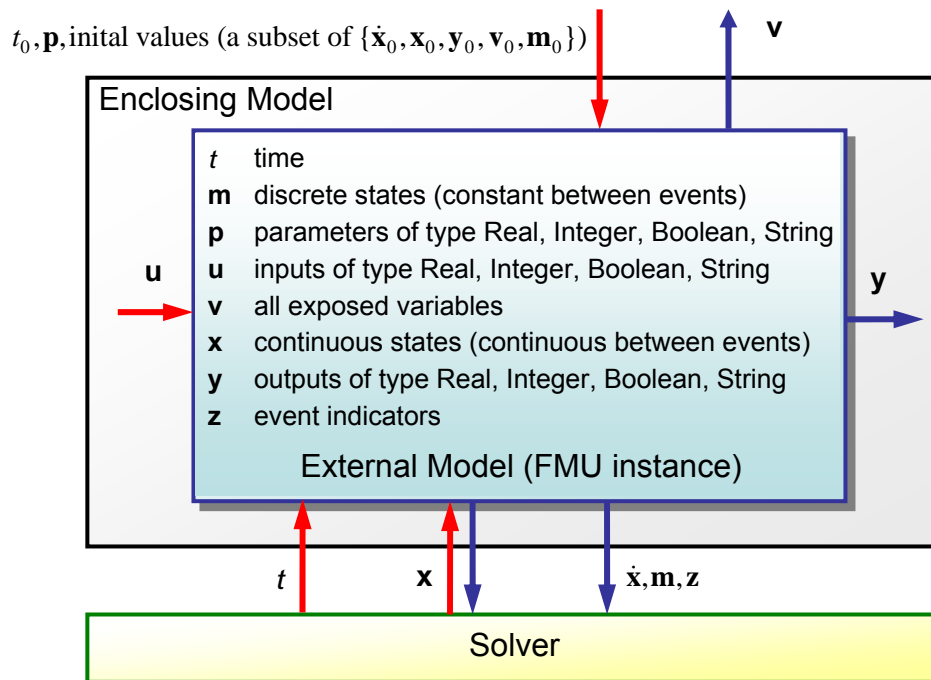

Figure 1: Data flow between the components, for details see section 2.1.

Blue arrows: Information provided by the FMU.

Red arrows: information provided to the FMU.

1.1. Properties and Guiding Ideas

In this section, properties are listed and some principles are defined that guided the low-level design of the Model Exchange interface. This shall increase self consistency of the interface functions. The listed issues are sorted, starting from high-level properties to low-level implementation issues.

Expressivity: The FMI provides the necessary features that Modelica[®], Simulink[®] and SIMPACK models² can be transformed to an FMU.

Implementation: FMUs can be written manually or can be generated automatically from a modelling environment. Existing manually coded models can be transformed manually to a model according to the FMI standard.

Processor independence: It is possible to distribute an FMU without knowing the target processor. This allows to run an FMU on a PC, a Hardware-in-the-Loop Simulation platform or as part of the controller software of an ECU, e. g. as part of an AUTOSAR SW-C. Keeping the FMU independent of the target processor increases the usability of the FMU and is even required by the AUTOSAR software component model. Implementation: using a textual FMU (distribute the C source of the FMU).

Simulator independence: It is possible to compile, link and distribute an FMU without knowing the target simulator. Reason: The standard would be much less attractive otherwise, unnecessarily restricting the later use of an FMU at compile time and forcing users to maintain simulator specific variants of an FMU. Implementation: using a binary FMU. When generating a binary

² Modelica is a registered trademark of the Modelica Association, Simulink is a registered trademark of the MathWorks Inc., SIMPACK is a registered trademark of SIMPACK AG.

FMU, e. g. a Windows dynamic link library (.dll) or a Linux shared object library (.so), the target operating system and eventually the target processor must be known. However, no run-time libraries, source files or header files of the target simulator are needed to generate the binary FMU. As a result, the binary FMU can be executed by any simulator running on the target platform (provided the necessary licenses are available, if required from the model or from the used run-time libraries).

Small run-time overhead : Communication between an FMU and a target simulator through the FMI does not introduce significant run time overhead. This is achieved by a new caching technique (to avoid to compute the same variables several time) and by exchanging vectors instead of scalar quantities.

Small footprint: A compiled FMU (the executable) is small. Reason: An FMU may run on an ECU (Electronic Control Unit, e.g., a micro processor), and ECUs have strong memory limitations. This is achieved by storing signal attributes (names, units, etc.) and all other information not needed for model evaluation in a separate text file (= Model Description File) that is not needed on the micro processor where the executable might run.

Hide data structure: The FMI for Model Exchange does not prescribe a data structure (a C struct) to represent a model. Reason: the FMI standard shall not unnecessarily restrict or prescribe a certain implementation of FMUs or simulators (whoever holds the model data), to ease implementation by different tool vendors.

Support many and nested FMUs: A simulator can run many FMUs in a single simulation run. The inputs and outputs of these FMUs can be connected with direct feed through. Moreover, an FMU may contain nested FMUs.

Numerical Robustness: The FMI standard allows that problems which are numerically critical (e.g. time and state events, multiple sample rates, stiff problems) can be treated in a robust way.

Hide cache: A typical FMU will cache computed results for later reuse. To simplify usage and to reduce error possibilities by a simulator, the caching mechanism is hidden from the FMI. Reason: First, the FMI should not force an FMU to implement a certain caching policy. Second, this helps to keep the FMI simple. Implementation: The FMI provides explicit methods (called by the simulator) for setting properties that invalidate cached data. An FMU that chooses to implement a cache may maintain a set of 'dirty' flags, hidden from the simulator. A get method, e. g. to a state, will then either trigger a computation, or return cached data, depending on the value of these flags.

Support numerical solvers: A typical target simulator will use numerical solvers. These solvers require vectors for states, derivatives and zero-crossing functions. The FMU directly fills the values of such vectors provided by the solvers. Reason: minimize execution time. The exposure of these vectors conflicts somewhat with the 'hide data structure' requirement, but the efficiency gain justifies this.

Explicit signature: The intended operations, argument types and return values are made explicit in the signature. For example, an operator (such as 'compute_derivatives') is not passed as an int argument but a special function is called for this. The 'const' prefix is used for any pointer that should not be changed, including 'const char*' instead of 'char*'. Reason: the correct use of the FMI can be checked at compile time and allow calling of the C code in a C++ environment (which is much stricter on 'const' as C is). This will help to develop FMUs that use the FMI in the intended way.

Few functions: The FMI consists of a few, 'orthogonal' functions, avoiding redundant functions, that could be defined in terms of others. Reason: This leads to a compact, easy to use, and hence attractive API with a compact documentation (the essential part is less than 30 pages).

Error handling: All FMI methods use a common set of methods to communicate errors.

Allocator must free: All memory (and other resources) allocated by the FMU are freed (released) by the FMU. Likewise, resources allocated by the simulator are released by the simulator. Reason: this helps to prevent memory leaks.

Immutable strings: All strings passed as arguments or returned are read-only and must not be modified by the receiver. Reason: This eases the reuse of strings.

Use C: The FMI is encoded using C, not C++. Inheritance of sub-interfaces can be implemented using `#include`. Reason: Avoid problems with compiler and linker dependent behavior. Run FMU on embedded target.

This version of the functional mock-up interface does not have the following desirable properties. They might be added in a future version:

- The interface is for ordinary differential equations in state space form (ODE). It is not for a general differential-algebraic equation system.
- Special features as might be useful for multi-body system programs, like SIMPACK, are not included.
- The interface is for simulation and for embedded systems. Properties that might be additionally needed for optimization are not included.
- No Jacobian matrix (neither dense nor sparse; tools have to derive this matrix numerically). The goal for the future is that large models, i. e., models with up to 10^4 continuous states and up to 10^6 variables, can be handled.
- No linearization data (A,B,C,D matrices of linearized model)
- No explicit definition of the variable hierarchy in the xml file.
- The number of states and number of event indicators are fixed and cannot be changed.
- Parameters are constant although it would be useful to change them online, e.g., for real-time training simulators.

1.2. Acknowledgements

This work was carried out within the ITEA2 MODELISAR project (project number: ITEA 2 – 07006, www.itea2.org/public/project_leaflets/MODELISAR_profile_oct-08.pdf).

Daimler AG, DLR, ITI GmbH, QTronic GmbH and SIMPACK AG thank BMBF for partial funding of this work within MODELISAR (BMBF Förderkennzeichen: 01IS08002).

Dynasim AB thanks the Swedish funding agency VINNOVA (2008-02291) for partial funding of this work within MODELISAR.

LMS Imagine thanks DGCIS for partial funding of this work within MODELISAR.

2. Model Interface

This chapter contains the interface description to access the equations of a dynamic system from a C program. Two header files are provided that define the interface. In both header files the convention is used that all C-functions and type definitions start with the prefix “fmi”:

- “fmiModelTypes.h”
contains the type definitions for the input and output arguments of the functions. This header file must be used both by the model and by the target simulator. If the target simulator has different definitions in the header file (e.g., “`typedef float fmiReal`” instead of “`typedef double fmiReal`”), then the model needs to be re-compiled with the header file used by the target simulator. Note, the header file platform for which the model was compiled can be inquired in the target simulator with function `fmiGetModelTypesPlatform()`, see section 2.4.
- “fmiModelFunctions.h”
contains the function prototypes that can be accessed in simulation environments and that are defined in this chapter. This header file, includes “fmiModelTypes.h”. Note, the header file version number for which the model was compiled, can be inquired in the target simulator with function `fmiGetVersion()`, see section 2.4.

The goal is that both textual and binary representations of models are supported and that several models might be present at the same time in an executable (e.g., model A may use a model B). In order that this is possible, the names of the functions in different models must be different or function pointers must be used. For simplicity, the first variant is utilized here by providing macros in “fmiModelFunctions.h” to build the actual function names. A typical implementation of the Model Exchange functions is as follows:

```
#define MODEL_IDENTIFIER MyModel
#include "fmiModelFunctions.h"
< implementation of the Model Exchange functions >
```

A function that is defined as “fmiGetDerivatives” is changed by the macros to the actual function name “MyModel_fmiGetDerivatives”, i.e., the function name is prefixed with the model name and an “_”. The “MODEL_IDENTIFIER” is defined in the Model Description File as attribute “modelIdentifier”, see section 3.1. A simulation environment can therefore construct the relevant function names by (a) generating code for the actual function call or (b) by dynamically loading a dynamic link library and explicitly importing the function symbols by providing the “real” function names as strings.

In the following sections, the types and the functions of the Model Exchange C-Interface as defined in the two header files are discussed in detail.

2.1. Mathematical Description

The goal of the Model Exchange interface is to numerically solve a system of differential, algebraic and discrete equations. In this version of the interface, ordinary differential equations in state space form with events are handled (abbreviated as “hybrid ODE”).

This type of system is described as a piecewise continuous system. Discontinuities can occur at time instants t_0, t_1, \dots, t_n , where $t_i < t_{i+1}$. These time instants are called “events”. Events can be known before hand (= time event), or are defined implicitly (= state and step events).

The “state” of a hybrid ODE is represented by a continuous state $\mathbf{x}(t)$ and by a time-discrete state $\mathbf{m}(t)$ that have the following properties:

- $\mathbf{x}(t)$ is a vector of real numbers (= time-continuous states) and is a continuous function of time inside each interval $t_i \leq t < t_{i+1}$, where $t_i = \lim_{\varepsilon \rightarrow 0} (t_i + \varepsilon)$, i.e., the right limit to t_i (note, $\mathbf{x}(t)$ is continuous between the right limit to t_i and the left limit to t_{i+1} respectively).
- $\mathbf{m}(t)$ is a set of real, integer, logical, and string variables (= time-discrete states) that is constant inside each interval $t_i \leq t < t_{i+1}$. In other words, $\mathbf{m}(t)$ changes value only at events. This means, $\mathbf{m}(t) = \mathbf{m}(t_i)$, for $t_i \leq t < t_{i+1}$.

At every event instant t_i , variables might be discontinuous and therefore have two values at this time instant, the "left" and the "right" limit. $\mathbf{x}(t_i)$, $\mathbf{m}(t_i)$ are always defined to be the right limit at t_i , whereas $\mathbf{x}^-(t_i)$, $\mathbf{m}^-(t_i)$ are defined to be the "left" limit at t_i , e.g.: $\mathbf{m}^-(t_i) = \mathbf{m}(t_{i-1})$. In the following figure, the two variable types are visualized:

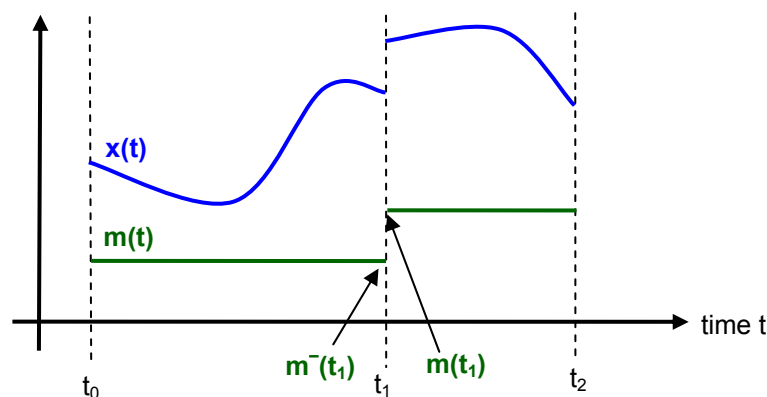

Figure 2: Piecewise-continuous states of an FMU: time-continuous (x) and time-discrete (m).

An event instant t_i is defined by one of the following conditions that gives the smallest time instant:

1. At a predefined time instant $t_i = T_{next}(t_{i-1})$ that was defined at the previous event instant t_{i-1} either by the FMU, or by the environment of the FMU due to a discontinuous change of an input signal³ u_j at t_i . Such an event is called time event.
2. At a time instant, where an event indicator $z_j(t)$ changes its domain from $z_j > 0$ to $z_j \leq 0$ or vice versa (see Figure 3 below). More precisely: An event $t = t_i$ occurs at the smallest time instant "min t " with $t > t_{i-1}$ where " $(z_j(t) > 0) \neq (z_j(t_{i-1}) > 0)$ ". Such an event is called state event.⁴ All event indicators are piecewise continuous and are collected together in one vector of real numbers $\mathbf{z}(t)$.

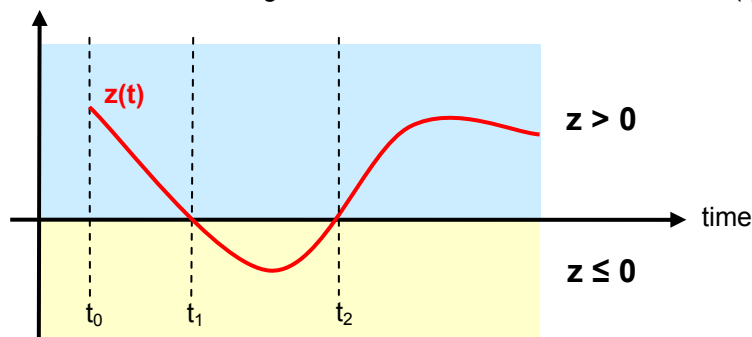

Figure 3: An event occurs when the event indicator changes its domain from $z > 0$ to $z \leq 0$ or vice versa.

³ Input signals are defined below.

⁴ This definition is slightly different as the usual standard definition of state events: " $z_j(t) \cdot z_j(t_{i-1}) \leq 0$ ". This often used definition has the severe drawback that $z_j(t_{i-1}) \neq 0$ is required in order to be well-defined and this condition cannot be guaranteed.

3. At every completed step of an integrator, `fmiCompletedIntegratorStep` must be called. An event occurs at this time instant, if indicated by the return argument `callEventUpdate`. Such an event is called step event. Step events are, e.g., used to dynamically change the (continuous) states of a model, because the previous states are no longer suited numerically, see appendix B.3.

An event is always triggered from the environment in which the FMU is called, so it is not triggered inside the FMU (see also Appendix B.2).

A model (FMU) may have additional variables **p**, **u**, **y**, **v** as defined below. These symbols characterize sets of real integer, logical, and string variables that are piecewise continuous over time, respectively. The non-real variables change their values only at events. For example, this means that $u_j(t) = u_j(t_i)$, for $t_i \leq t < t_{i+1}$, if u_j is an integer, logical or string variable. If u_j is a real variable, it is either a continuous function of time inside this interval or it is constant in this interval (= time-discrete). This property is defined in the Model Description File (see section 3.3). The variables have the following meaning:

- Parameters $\mathbf{p}(t) = \mathbf{p}(t_0)$ for $t \geq t_0$. The values of these variables are constant after initialization. The parameters that do not have a “start” value with “fixed=true” in the model description file, see section 3.3, are computed during initialization (e.g. as functions of other parameters or more complicated conditions such as: determine spring constant so that the system has a certain state after initialization).
- Input variables $\mathbf{u}(t)$. The values of these variables are defined outside of the model.
- Output variables $\mathbf{y}(t)$. These variables are designed to be used in a model connection. So output variables might be used in the calling function as input values to other FMUs or other submodels.
- Internal variables $\mathbf{v}(t)$. These variables are internal variables of the model that are not used in connections and are only exposed by the model to inspect results.

Based on the above prerequisites, the mathematical description of an FMU is defined as:

description	range of t	equation	function names
initialization	$t = t_0$	$(\mathbf{m}, \mathbf{x}, \mathbf{p}, T_{next}) = \mathbf{f}_0(\mathbf{u}, t_0,$ subset of $\{\mathbf{p}, \dot{\mathbf{x}}_0, \mathbf{x}_0, \mathbf{y}_0, \mathbf{v}_0, \mathbf{m}_0\}$)	<code>fmiInitialize</code> <code>fmiGetReal/Integer/Boolean/String</code> <code>fmiGetContinuousStates</code> <code>fmiGetNominalContinuousStates</code>
derivatives $\dot{\mathbf{x}}(t)$	$t_i \leq t < t_{i+1}$	$\dot{\mathbf{x}} = \mathbf{f}_x(\mathbf{x}, \mathbf{m}, \mathbf{u}, \mathbf{p}, t)$	<code>fmiGetDerivatives</code>
outputs $\mathbf{y}(t)$	$t_i \leq t < t_{i+1}$	$\mathbf{y} = \mathbf{f}_y(\mathbf{x}, \mathbf{m}, \mathbf{u}, \mathbf{p}, t)$	<code>fmiGetReal/Integer/Boolean/String</code>
internal variables $\mathbf{v}(t)$	$t_i \leq t < t_{i+1}$	$\mathbf{v} = \mathbf{f}_v(\mathbf{x}, \mathbf{m}, \mathbf{u}, \mathbf{p}, t)$	<code>fmiGetReal/Integer/Boolean/String</code>
event indicators $\mathbf{z}(t)$	$t_i \leq t < t_{i+1}$	$\mathbf{z} = \mathbf{f}_z(\mathbf{x}, \mathbf{m}, \mathbf{u}, \mathbf{p}, t)$	<code>fmiGetEventIndicators</code>
event update	$t = t_{i+1}$	$(\mathbf{x}, \mathbf{m}, T_{next}) = \mathbf{f}_m(\mathbf{x}^-, \mathbf{m}^-, \mathbf{u}, \mathbf{p}, t_{i+1})$	<code>fmiEventUpdate</code> <code>fmiGetReal/Integer/Boolean/String</code> <code>fmiGetContinuousStates</code> <code>fmiGetNominalStates</code> <code>fmiGetStateValueReferences</code>
event $t = t_{i+1}$ is triggered if		$t = T_{next}(t_i)$ or $\min_{t > t_i} t : (z_j(t) > 0) \neq (z_j(t_i) > 0)$ or step event	

$$t \in \mathbb{R}, \mathbf{p} \in \mathbb{P}^{np}, \mathbf{u}(t) \in \mathbb{P}^{nu}, \mathbf{m}(t) \in \mathbb{P}^{nm}, \mathbf{x}(t) \in \mathbb{R}^{nx}, \mathbf{y}(t) \in \mathbb{P}^{ny}, \mathbf{v}(t) \in \mathbb{P}^{nv}, \mathbf{z}(t) \in \mathbb{R}^{nz}$$

(\mathbb{R} : real variable; \mathbb{P} : real or integer or Boolean or string variable)

$\mathbf{f}_x, \mathbf{f}_y, \mathbf{f}_v, \mathbf{f}_z \in C^0$ (= continuous functions with respect to all input arguments) inside $t_i \leq t < t_{i+1}$

where $t_i = \lim_{\varepsilon \rightarrow 0} (t_i + \varepsilon)$ and for all variables $\mathbf{w} = \{\mathbf{u}, \mathbf{v}, \mathbf{x}, \mathbf{y}, \mathbf{z}\}$: $\mathbf{w}(t_i)$ is the right limit of \mathbf{w} at t_i .

Table 1: Mathematical description of an FMU (Functional Mock-up Unit).

An FMU is initialized with $f_0(\dots)$. In order to remain flexible and allow to use special initialization algorithms inside the model, the input arguments to this function are defined in the description schema (see section 3.3). This includes initial variable values, as well as guess values for iteration variables of algebraic equation systems, in order to compute the continuous and discrete states at the initial time t_0 . In the above table, this situation is described by stating that part of the input arguments to $f_0(\dots)$ are a subset of the initial values of all time varying variables appearing in the model equations. For example, initialization might be defined by the initial states, x_0 , or by stating that the state derivatives are zero ($\dot{x} = \mathbf{0}$). Initialization is a difficult topic by itself and it is assumed that the modelling environment generating the model code provides the initialization.

After initialization, integration is started. Basically, in this phase the derivatives of the continuous states are computed with $f_x(\dots)$. If FMUs and/or submodels are connected together, then the inputs of these models are the outputs of other models and therefore $f_y(\dots)$ must be called to compute outputs. Whenever result values shall be stored, usually at communication points defined before the start of the simulation, function $f_v(\dots)$ must be called.

Continuous integration is stopped at an event instant. An event instant is determined by a time, state, or step event. In order to determine a state event, function $f_z(\dots)$ has to be called at every completed integrator step. Once the event indicators signal a change of their domain, an iteration over time is performed between the previous and the actual completed integrator step, in order to determine the time instant of the domain change up to a certain precision.

After an event is triggered, function $f_m(\dots)$ is called. This function returns with the new values of the (time-) continuous and (time-) discrete states. As input arguments the values of the states are used, just before the event was triggered. Inside function $f_m(\dots)$, an event iteration may take place until the new state values are determined. This might be a simple fixed point iteration, or the solution of a mixed equation system, with real, integer, logical and string unknowns.

The function calls in the table above describe precisely, which input arguments are needed to compute the desired output argument(s). There is no 1:1 mapping of these mathematical functions to C-functions. Instead, all input arguments are set with `fmiSetXXX(...)` C-function calls and then the result argument(s) can be determined with the C-functions defined in the right column of the above table. This technique is discussed in detail in section 2.6. In short: For efficiency reasons, all equations from the table above will usually be available in one (internal) C-function. With the C-functions described in the next sections, input arguments are copied into the internal model data structure only when their value has changed in the environment. With the C-functions in the right column of the table above, the internal function is called in such a way, that only the minimum needed equations are evaluated. Hereby, variable values calculated from previous calls can be reused. This technique is called “caching” and can significantly enhance the simulation efficiency of real-world models. For a more detailed explanation, see appendix B.4.

2.2. Platform Dependent Definitions (fmiModelTypes.h)

In order to simplify porting, no C types are used in the function interfaces, but the alias types defined in this section. All definitions in this section are provided in the header file “`fmiModelTypes.h`”.

```
#define fmiModelTypesPlatform "standard32"
```

A definition that can be inquired with function `fmiGetModelTypesPlatform`. It defines the platform for which this header file is provided. A platform is a combination of machine, compiler, operating system. The default definition “standard32” defines a standard 32-bit platform:

```
fmiComponent      : 32 bit pointer  
fmiValueReference: 32 bit  
fmiReal           : 64 bit  
fmiInteger        : 32 bit  
fmiBoolean        : 8 bit  
fmiString         : 32 bit pointer
```

```
typedef void* fmiComponent;
```

This is a pointer to a model specific data structure that contains the information needed to process the model equations. This data structure is implemented by the modelling environment that provides the dynamic system model, i.e., the calling environment does not know its content and the code to process it must be provided by the modelling environment and must be shipped together with the model.

```
typedef unsigned int fmiValueReference;
```

This is a handle to a (base type) variable value of the model. The handle is unique at least with respect to the corresponding base type (like `fmiReal`) besides alias variables that have the same handle. All structured entities, like records or arrays, are “flattened” in to a set of scalar values of type `fmiReal`, `fmiInteger` etc. A `fmiValueReference` references one such scalar. The coding of `fmiValueReference` is a “secret” of the modelling environment that generated the model. The interface to the equations only provides access to variables via this handle. Extracting concrete information about a variable is specific to the used environment that reads the Model Description File in which the value handles are defined.

If a function in the following sections is called with a wrong “`fmiValueReference`” value (e.g. setting a constant with a `fmiSetReal(..)` function call), then the function has to return with an error (`fmiStatus = fmiError`, see section 2.3), i.e., the processing of the respective model instance must be terminated.

```
#define fmiUndefinedValueReference (fmiValueReference) (-1)
```

If `fmiValueReference` is undefined, it has the value `fmiUndefinedValueReference` which is the largest value of `unsigned int`. This value might be used, e.g., as return argument of `fmiGetStateValueReferences`, (see section 2.7) in order to hide the meaning of a state.

```
typedef double      fmiReal    ; // Real number (64 bits)
typedef int         fmiInteger; // Integer number (32 bits)
typedef char        fmiBoolean; // Boolean number
                                     // (8 bit, two values: fmiFalse, fmiTrue)
typedef const char* fmiString ; // Character string
                                     // ('\0' terminated, UTF8 encoding)

#define fmiTrue 1
#define fmiFalse 0
```

These are the basic data types used in the interfaces of the C-functions. More data types might be included in future versions of the interface. In order to keep flexibility, especially for embedded systems or for high performance computers, the exact data types or the word length of a number is not standardized. Instead, the precise definition (i.e., the header file “`fmiModelTypes.h`”) is provided by the environment where the FMU shall be called. In most cases, the definition above will be used. If the target environment has another definition and the FMU is distributed in binary format, it must be newly generated with this target header file.

If a `fmiString` variable is passed as input argument to a function and the string shall be used after the function has returned, the whole string must be copied (not only the pointer) and stored in the internal model memory, because there is no guarantee for the lifetime of the string after the function has returned.

If a `fmiString` variable is passed as output argument from a function and the string shall be used in the target environment, the whole string must be copied (not only the pointer). The memory of this string may be deallocated by the next call to any of the interface functions (the string memory might also be just a buffer, that is reused)

2.3. Status Returned by Functions

This section defines the “status” flag (an enumeration of type `fmiStatus` defined in file “`fmiModelFunctions.h`”) that is returned by all functions to indicate the success of the function call:

```
typedef enum {fmiOK,  
             fmiWarning,  
             fmiDiscard,  
             fmiError,  
             fmiFatal} fmiStatus;
```

Status returned by functions. The status has the following meaning

- `fmiOK` – all well
- `fmiWarning` – there are things not quite right, but the computation can continue. Function “logger” was called in the model (see below) and it is expected that this function has shown the prepared information message to the user.
- `fmiDiscard` – this return status is only possible, if explicitly defined for the corresponding function (currently⁵: `fmiSetReal`, `fmiSetContinuousStates`, `fmiGetReal`, `fmiGetDerivatives`, `fmiGetEventIndicators`): It is recommended to perform a smaller step size and evaluate the model equations again, e.g., because an iterative solver in the model did not converge or because a function is outside of its domain (e.g. `sqrt(<negative number>)`). If this is not possible, the simulation has to be terminated. Function “logger” was called in the model (see below) and it is expected that this function has shown the prepared information message to the user if the model was called in debug mode (`loggingOn = fmiTrue`). Otherwise, “logger” should not show a message.
- `fmiError` – the model encountered an error, the simulation cannot be continued with this model instance and function `fmiFreeModelInstance(...)` **must** be called. Further processing is possible after this call, especially, other model instances are not affected. Function “logger” was called in the model (see below) and it is expected that this function has shown the prepared information message to the user.
- `fmiFatal` – the model computations are irreparably corrupted for all model instances. Function “logger” was called in the model (see below) and it is expected that this function has shown the prepared information message to the user. It is not possible to call any other function for any of the model instances.

2.4. Inquire Platform and Version Number of Header Files

This section documents functions to inquire information about the header files.

```
const char* fmiGetModelTypesPlatform();
```

Returns the name of the set of (compatible) platforms of the “`fmiModelTypes.h`” header file which was used to compile the functions of the Model Exchange interface. The function returns a pointer to the static variable “`fmiModelTypesPlatform`” defined in this header file. The standard header file as documented in this specification has version “`standard32`” (so this function usually returns “`standard32`”).

```
const char* fmiGetVersion();
```

⁵ `fmiSetReal` and `fmiSetContinuousStates` could check whether the input arguments are in their validity range. If not, these functions could return with `fmiDiscard`.

Returns the version of the “fmiModelFunctions.h” header file which was used to compile the functions of the Model Exchange interface. The function returns “fmiVersion” which is defined in this header file. The standard header file as documented in this specification has version “1.0” (so this function usually returns “1.0”).

2.5. Creation and Destruction of Model Instances

This section documents functions that deal with instantiation and destruction of dynamic system models and that define the desired logging status.

```
fmiComponent fmiInstantiateModel(fmiString instanceName, fmiString GUID,  
                                fmiCallbackFunctions functions,  
                                fmiBoolean loggingOn);
```

Returns a new instance of a model. If a null pointer is returned, then instantiation failed. In that case, function “functions->logger” was called. A model can be instantiated many times. This function must be called successfully, before any of the following functions can be called.

Argument `instanceName` is used to name the instance, e.g. in error or information messages generated by one of the `fmiXXX` functions. This string must be non-empty (i.e., must have at least one character that is no white space).

Argument `GUID` is used to check that the Model Description File is compatible with the model functions: `GUID` is a vendor specific globally unique identifier of the Model Description File. It is stored in the description file and in the model equations and the `GUID` read from the Model Description File and passed to `fmiInstantiateModel` must be identical to the one stored in the function (e.g., it is a “fingerprint” of the relevant information stored in the description file), otherwise the model equations and the Model Description File are not consistent to each other.

Argument `functions` provides callback functions to be used from the model functions to utilize resources from the environment (see type `fmiCallbackFunctions` below).

If `loggingOn = fmiTrue`, debug logging is enabled. If `loggingOn = fmiFalse`, debug logging is disabled.

The string-valued arguments `instanceName` and `GUID` passed to this function, must be copied inside this function, because there is no guarantee for a string lifetime after this function returned.

```
typedef struct {  
    void (*logger)(fmiComponent c, fmiString instanceName, fmiStatus status,  
                  fmiString category, fmiString message, ...);  
    void* (*allocateMemory)(size_t nobj, size_t size);  
    void (*freeMemory)(void* obj);  
} fmiCallbackFunctions;
```

The struct contains pointers to functions provided by the environment to be used by the model functions. It is not allowed to pass NULL pointers. In the default `fmiModelFunctions.h` file, typedefs for the function definitions are present (`fmiCallbackLogger`, `fmiCallbackAllocateMemory`, `fmiCallbackFreeMemory`) to simplify the usage. This is non-normative. The functions have the following meaning:

Function **logger**:

Pointer to a function that is called in the model, usually if the model function does not behave as desired. If “logger” is called with “status = `fmiOK`”, then the message is a pure information message. “instanceName” is the instance name of the model that calls this function. “category” is the category of the message. Usually, “category” is only used for debug messages in order that

the environment can filter the debug messages to be shown. The meaning of “category” is defined by the modelling environment that generated the model code. Argument “message” is provided in the same way and with the same format control as in “`printf(..)`”. In the simplest case, this function might only print the message. It might also just store the message in a stack of buffers and via options in the environment the printing of the messages is controlled.

All string-valued arguments passed by the FMU to the logger may be deallocated by the FMU directly after function `logger` returns. The environment must therefore create copies of these strings if it needs to access these strings later.”

The logger function will append a line break to each `message` when writing messages after each other to a terminal or file (the messages may also be shown in other ways, e.g. as separate text-boxes in a GUI). The caller may include line-breaks (using “`\n`”) within the message, but should avoid trailing line breaks.

Variables can be referenced in a message with “`#<Type><valueReference>#`” where `<Type>` is “`r`” for `fmiReal`, “`i`” for `fmiInteger`, “`b`” for `fmiBoolean` and “`s`” for `fmiString` (this is necessary, if the variable names are not stored in the C-functions in order to avoid any overhead). If character “`#`” shall be included in the message, it has to be prefixed with “`#`”, so “`#`” is an escape character. Example:

A message of the form

```
“#r1365# must be larger than zero (used in IO channel ##4)”
```

might be changed by the environment to

```
“body.m must be larger than zero (used in IO channel #4)”
```

if “`body.m`” is the name of the `fmiReal` variable with `fmiValueReference = 1365`.

Function **allocateMemory**:

Pointer to a function that is called in the model if memory needs to be allocated. It is not allowed that the model uses `malloc`, `calloc` or other memory allocation functions. One reason is that these functions might not be available for embedded systems on the target machine. Another reason is that the environment may have optimized or specialized memory allocation functions. “`allocateMemory`” returns a pointer to space for a vector of “`nobj`” objects, each of size “`size`” or `NULL`, if the request cannot be satisfied. The space is initialized to zero bytes (a simple implementation is to use `calloc` from the C standard library).

Function **freeMemory**:

Pointer to a function that must be called in the model if memory is freed that has been allocated with “`allocateMemory`”. If a `NULL` pointer is provided as input argument `obj`, the function shall perform no action (a simple implementation is to use `free` from the C standard library; in ANSI C89 and C99, the null pointer handling is identical as defined here).

```
void fmiFreeModelInstance(fmiComponent c);
```

Dispose the given model instance and deallocate all the allocated memory and other resources that have been allocated by the functions of the Model Exchange Interface for instance “`c`”. If “`c`” is a `NULL` pointer, the function call is ignored (does not have an effect).

```
fmiStatus fmiSetDebugLogging(fmiComponent c, fmiBoolean loggingOn)
```

If `loggingOn=fmiTrue`, debug logging is enabled, otherwise it is switched off for instance “`c`”

2.6. Providing Independent Variables and Re-initialization of Caching

Depending on the situation, different variables need to be computed. In order to be efficient, it is important that the interface requires only the computation of variables that are needed in the present

context. For example, during the iteration of an integrator step, only the state derivatives need to be computed, provided the output of a model is not connected. It might be that at the same time instant other variables are needed. For example, if an integrator step is completed, the event indicator functions need to be computed as well. For efficiency it is then important that in the call to compute the event indicator functions, the state derivatives are not newly computed, if they have been computed already at the present time instant. This means, the state derivatives shall be reused from the previous call. This feature is called “caching of variables” in the sequel. An example for caching and a sketch how to implement it, is given in appendix B.4.

Caching requires that the model evaluation can detect when the input arguments, like time or states, have changed. This is achieved by setting them explicitly with a function call, since every such function call signals precisely a change of the corresponding variables. For this reason, this section contains functions to set the input arguments of the equation evaluation functions. This is unproblematic for time and states, but is more involved for parameters and inputs, since the latter may have different data types.

All variable values are identified with a variable handle called “value reference”. The handle is defined in the Model Description Schema (as “valueReference” in element “ScalarVariable”). Whether or not the “valueReference” is unique, is a secret of the modelling environment that generated the C-functions and this information cannot be utilized by the simulation environment. The only guarantee is that valueReference is unique for a particular base data type (Real, Integer/Enumeration, Boolean, String) with exception of alias variables (variables with alias = “alias” or “negatedAlias” have the same valueReference as the variable to which they are aliased).

```
fmiStatus fmiSetTime(fmiComponent c, fmiReal time);
```

Set a new time instant and re-initialize caching of variables that depend on time (variables that depend solely on constants or parameters need not to be newly computed in the sequel, but the previously computed values can be reused).

```
fmiStatus fmiSetContinuousStates(fmiComponent c, const fmiReal x[], size_t nx);
```

Set a new (continuous) state vector and re-initialize caching of variables that depend on the states. Argument `nx` is the length of vector `x` and is provided for checking purposes (variables that depend solely on constants, parameters, time, and inputs need not to be newly computed in the sequel, but the previously computed values can be reused). Note, `fmiEventUpdate` might change the continuous states as well.

Note: `fmiStatus = fmiDiscard` is possible.

```
fmiStatus fmiCompletedIntegratorStep(fmiComponent c,  
                                     fmiBoolean* callEventUpdate);
```

This function must be called by the environment after every completed step of the integrator. If the function returns with `callEventUpdate = fmiTrue`, then the environment has to call `fmiEventUpdate(..)`, otherwise, no action is needed.

When the integrator step is completed and the states are modified by the integrator afterwards (e.g., correction by a BDF method), then `fmiSetContinuousStates(..)` has to be called with the updated states before `fmiCompletedIntegratorStep(..)` is called.

This function might be used, e.g., for the following purposes:

1. *Delays:*

All variables that are used in a “`delay(..)`” operator are stored in an appropriate buffer and the function returns with `callEventUpdate = fmiFalse`.

2. *Dynamic state selection:*

It is checked whether the dynamically selected states are still numerically appropriate. If yes, the function returns with `callEventUpdate = fmiFalse` otherwise with `fmiTrue`. In the

latter case, `fmiEventUpdate(..)` has to be called and changes the states dynamically.

```
fmiStatus fmiSetReal (fmiComponent c, const fmiValueReference vr[], size_t nvr,
                    const fmiReal value[]);
fmiStatus fmiSetInteger(fmiComponent c, const fmiValueReference vr[], size_t nvr,
                       const fmiInteger value[]);
fmiStatus fmiSetBoolean(fmiComponent c, const fmiValueReference vr[], size_t nvr,
                       const fmiBoolean value[]);
fmiStatus fmiSetString (fmiComponent c, const fmiValueReference vr[], size_t nvr,
                       const fmiString value[]);
```

Set independent parameters, inputs, start values and re-initialize caching of variables that depend on these variables. Argument “vr” is a vector of “nvr” value handles that define the variables that shall be set. Argument “value” is a vector with the actual values of these variables.

All strings passed as arguments to `fmiSetString` must be copied inside this function, because there is no guarantee of the lifetime of strings, when this function returns.

Note: `fmiStatus = fmiDiscard` is possible for `fmiSetReal`.

Restrictions on using the “`fmiSetReal/Integer/Boolean/String`” functions (see also section 2.9):

1. These functions can be called on inputs (`ScalarVariable.Causality = “input”`), after calling `fmiInstantiateModel` and before `meFreeModel`.
2. Additionally, these functions can be called on variables that have a “`ScalarVariable / <type> / start`” attribute, after calling `fmiInstantiateModel` and before calling `fmiInitialize`. If these functions are not called on a variable with a “start” attribute, then the “start” value of this variable in the C-functions is this “start” value (so this start value must be stored both in the xml-file and in the C-functions).

The functions above have the slight drawback that values must always be copied, e.g., a call to “`fmiSetContinuousStates`” will provide the actual states in a vector and this function has to copy the values in to the internal model data structure “c” so that subsequent evaluation calls can utilize these values. If this turns out to be an efficiency issue, a future release of FMI might provide additional functions to provide the address of a memory area where the variable values are present.

2.7. Evaluation of Model Equations

This section contains the core functions to evaluate the model equations. Before one of these functions can be called, the appropriate functions from the previous section have to be used, to set the input arguments to the current model evaluation.

```
fmiStatus fmiInitialize(fmiComponent c, fmiBoolean toleranceControlled,
                      fmiReal relativeTolerance, fmiEventInfo* eventInfo);

typedef struct{
    // only meaningful for fmiEventUpdate (fmiInitialize returns with fmiTrue):
    fmiBoolean iterationConverged;
    fmiBoolean stateValueReferencesChanged; // valueReferences of states x changed
    fmiBoolean stateValuesChanged;         // values of states x changed

    // meaningful for fmiInitialize and for fmiEventUpdate:
    fmiBoolean terminateSimulation;
    fmiBoolean upcomingTimeEvent; // if fmiTrue, nextEventTime is next time event
    fmiReal    nextEventTime;
} fmiEventInfo;
```

Initializes the model, i.e., computes initial values for all variables. Before calling this function, `fmiSetTime()` must be called, and all variables with a “ScalarVariable / <type> / start” attribute or a setting of `ScalarVariable.causality = “input”` can be set with the “`fmiSetXXX`” functions (the `ScalarVariable` attributes are defined in the Model Description File, see section 3). Setting other variables is not allowed (with exception of `ScalarVariable.causality = “none”`).

If “`toleranceControlled = fmiTrue`” then the model is called with a numerical integration scheme where the step size is controlled by using “`relativeTolerance`” for error estimation. In such a case, all numerical algorithms used inside the model (e.g. to solve non-linear algebraic equations) should also operate with an error estimation of an appropriate smaller relative tolerance.

The function returns once initialization is finished (or when used in `fmiEventUpdate`, when a new consistent state has been found) and the integration can be restarted. The function returns with `eventInfo`. This structure is also used as return value of `fmiEventUpdate`. The variables of the structure have the following meaning:

Arguments `iterationConverged`, `stateValueReferencesChanged`, and `stateValuesChanged` are only meaningful when returning from `fmiEventUpdate`. When returning from `fmiInitialize`, all three flags are always `fmiTrue`.

If `stateValuesChanged = fmiTrue` when `iterationConverged = fmiTrue`, then at least one element of the continuous state vector has changed its value, e.g., since at initial time, or due to an impulse. The new values of the states must be inquired with function `fmiGetContinuousStates`.

If `stateValueReferencesChanged = fmiTrue` when `iterationConverged = fmiTrue`, then the meaning of the states has changed. The `valueReferences` of the new states can be inquired with `fmiGetStateValueReferences` and the nominal values of the new states can be inquired with `fmiGetNominalContinuousStates`.

If `terminateSimulation = fmiTrue`, the simulation shall be terminated (successfully). It is assumed that an appropriate message is printed by the FMU to explain the reason for the termination.

If `upcomingTimeEvent = fmiTrue`, then the simulation shall integrate at most until `time = nextEventTime`, and shall call `fmiEventUpdate` at this time instant. If integration is stopped before `nextEventTime`, e.g., due to a state event, the definition of `nextEventTime` becomes obsolete.

[Currently, this function can only be called once for one instance. Note, even if it can only be called once, an event can be triggered and then event iteration via `fmiEventUpdate` is possible at the initial time.]

```
fmiStatus fmiGetDerivatives      (fmiComponent c, fmiReal derivatives[], size_t nx);
fmiStatus fmiGetEventIndicators(fmiComponent c, fmiReal eventIndicators[],
                                size_t ni);
```

Compute state derivatives and event indicators at the current time instant and for the current states. The derivatives are returned as a vector with “`nx`” elements. A state event is triggered when the domain of an event indicator changes from $z_j > 0$ to $z_j \leq 0$ or vice versa (see section 2.1). The FMU must guarantee that at an event restart $z_j \neq 0$, e.g., by shifting z_j with a small value. Furthermore, z_j should be scaled in the FMU with its nominal value (see appendix B.2). The event indicators are returned as a vector with “`ni`” elements.

The ordering of the elements of the derivatives vector is identical to the ordering of the state vector (e.g. `derivatives[2]` is the derivative of `x[2]`). Event indicators are not necessarily related to variables on the Model Description File.

Note: `fmiStatus = fmiDiscard` is possible for both functions.

```
fmiStatus fmiGetReal (fmiComponent c, const fmiValueReference vr[], size_t nvr,  
                    fmiReal value[]);  
fmiStatus fmiGetInteger(fmiComponent c, const fmiValueReference vr[], size_t nvr,  
                       fmiInteger value[]);  
fmiStatus fmiGetBoolean(fmiComponent c, const fmiValueReference vr[], size_t nvr,  
                       fmiBoolean value[]);  
fmiStatus fmiGetString (fmiComponent c, const fmiValueReference vr[], size_t nvr,  
                       fmiString value[]);
```

Get actual values of variables by providing the variable handles. These functions are especially used to get the actual values of output variables if a model is connected with other models. Furthermore, the actual value of every variable defined in the Model Description File can be determined at every time instant. The string returned by `fmiGetString` must be copied in the target environment, because the allocated memory for this string might be deallocated by the next call to any of the fmi interface functions or it might be an internal string buffer that is just reused.

Note: `fmiStatus = fmiDiscard` is possible for `fmiGetReal` (but not for `fmiGetInteger`, `fmiGetBoolean`, `fmiGetString`, because these are discrete variables and their values can only change at an event instant where `fmiDiscard` does not make sense)..

```
fmiStatus fmiEventUpdate(fmiComponent c, fmiBoolean intermediateResults,  
                       fmiEventInfo* eventInfo);
```

```
typedef struct{...} fmiEventInfo; // see fmiInitialize(..)
```

This function is called after a time, state or step event occurred. The function returns with `eventInfo` (for details see function `fmiInitialize`). If “`intermediateResults = fmiFalse`”, the function returns once a new consistent state has been found and the integration can be restarted. If the argument is `fmiTrue`, then the function returns for every event iteration that is performed internally, in order to allow to get result variables after every iteration with the `fmiGetXXX` functions above. The function has to be called successively then until “`eventInfo->iterationConverged = fmiTrue`” and has to return the final status of `eventInfo->stateValueReferencesChanged` and of `eventInfo->stateValuesChanged`.

```
fmiStatus fmiGetContinuousStates(fmiComponent c, fmiReal x[], size_t nx);
```

Return the new (continuous) state vector x after an event iteration has finished (including initialization). This function has to be called after initialization and if the (continuous) state vector has changed at an event instant after calling `fmiEventUpdate(..)` with `eventInfo->iterationConverged = fmiTrue`.

```
fmiStatus fmiGetNominalContinuousStates(fmiComponent c, fmiReal x_nominal[],  
                                       size_t nx);
```

Return the nominal values of the continuous states. This function should always be called after `fmiInitialize`, and if `eventInfo->stateValueReferencesChanged = fmiTrue` in `fmiEventUpdate`, since then the association of the continuous states to variables has changed and therefore also their nominal values. If the FMU does not have information about the nominal value of a continuous state i , a nominal value `x_nominal[i] = 1.0` should be returned. Typically, the nominal values of the continuous states are used to compute the absolute tolerance required by the integrator, e.g.:

```
absoluteTolerance[i] = 0.01*relativeTolerance*x_nominal[i];
```

```
fmiStatus fmiGetStateValueReferences(fmiComponent c, fmiValueReference vrx[],  
                                    size_t nx);
```

Return the value references of the state vector (e.g. used to print the information message which variable restricts most often the step size). In case of dynamic state selection, the value references may change after calling `fmiEventUpdate(..)`. In this case `fmiEventUpdate` returns with `eventInfo-> stateValueReferencesChanged = fmiTrue`.

If `vrx[i] = fmiUndefinedValueReference` (see section 2.2), the model is hiding the meaning of the state and no value reference for this state is returned.

```
fmiStatus fmiTerminate(fmiComponent c);
```

Terminate the model evaluation at the end of a simulation or after a desired stop of the integration before the simulation end. Release all resources that have been allocated since `fmiInitialize` has been called.. After calling this function, the final values of all variables can be inquired with the `fmiGetXXX(..)` functions above. It is not allowed to call this function after one of the functions returned with a status flag of `fmiError` or `fmiFatal`.

2.8. External Models

An FMU may use other FMUs which may use other FMUs. So an FMU may consist of a hierarchy of FMUs (also called external models). All variables in an external model that shall be visible and/or accessible from the environment need to be “exposed”, i.e., in the root-level model a corresponding variable needs to be defined and in the generated code this variable must be assigned to the corresponding variable of the external model. As a result, only variables from the top most model are visible/accessible from the environment where the model is called. Note, continuous states of an external model must always be exposed. The hierarchical model structure is not exposed in the FMU model distribution, so in the model zip-file only one FMU is contained.

2.9. State Machine of Calling Sequence

Every implementation of the FMI must support calling sequences of the functions according to the following state machine:

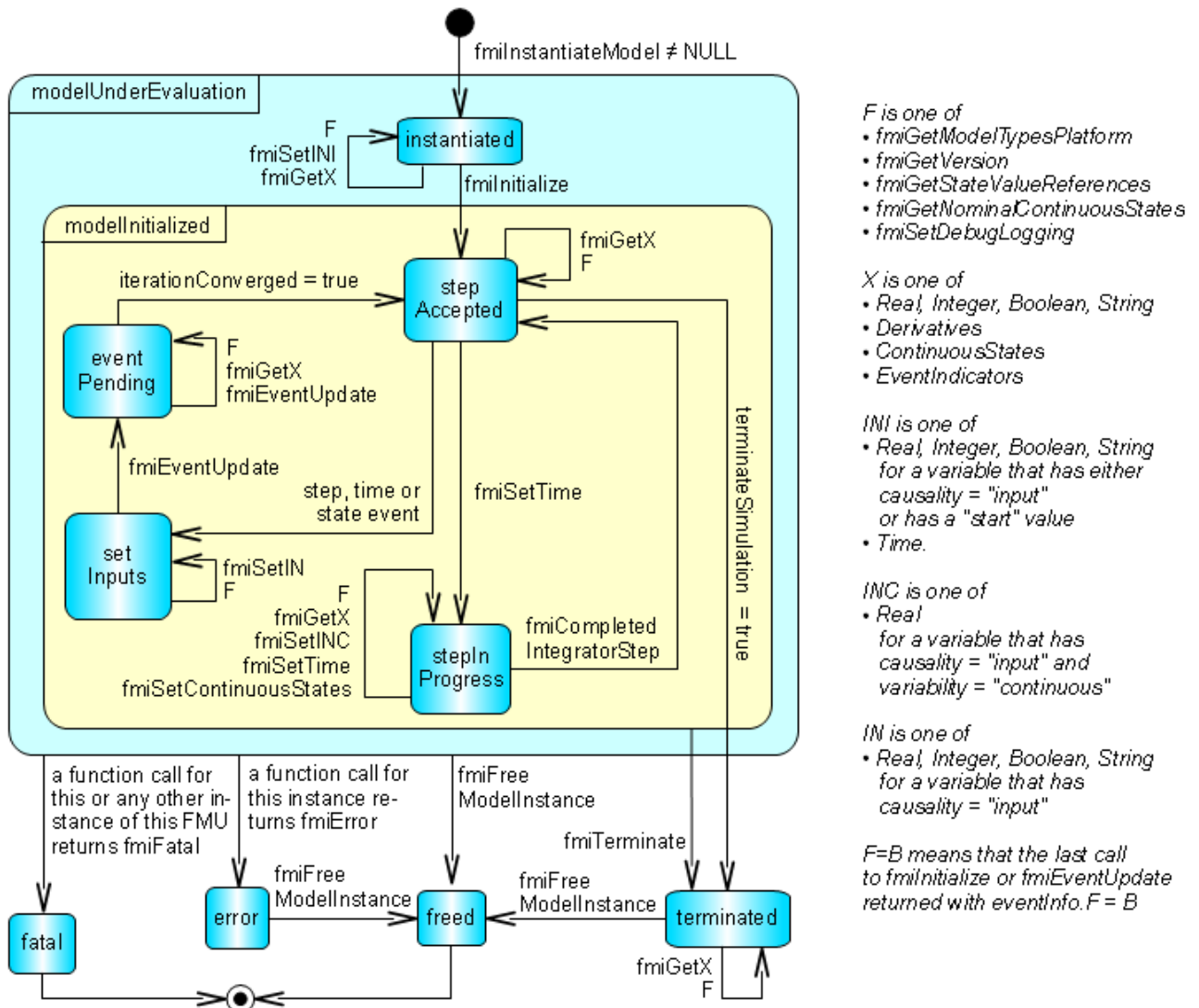

Figure 4: Calling sequence of Model Exchange C-functions in form of an UML 2.0 state machine.

If a transition is labelled with one or more function names (e.g. *fmiGetReal*, *fmiGetInteger*) this means that the transition is taken if any of these functions is successfully called. The transition conditions "step event", "time event", and "state event" are defined in section 2.1. Each state of the state machine corresponds to a certain phase of a simulation as follows:

- **instantiated:**
In this state, inputs, start and guess values can be set.
- **stepAccepted:**
In this state, the solution at initial time, after a completed integrator step, or after event iteration can be retrieved. If *fmiInitialize* or *fmiEventUpdate* return with *eventInfo.terminated = fmiTrue*, a transition to state "terminated" occurs.
- **stepInProgress:**
In this state, an integrator step is performed. Also, the event time of a state event may be determined here

after a domain change of at least one event indicator was detected at the end of a completed integrator step.

- **setInputs:**

Before starting with the event handling, changed (continuous or discrete) inputs have to be set.

- **eventPending:**

In this state, at least one event is waiting to be processed by a call to `fmiEventUpdate`. Intermediate results of the event iteration can be retrieved. If `fmiEventUpdate` returns with `eventInfo.iterationConverged = fmiTrue`, then this state is left and the state machine continues in state "retrieveSolution".

- **terminated:**

In this state, the solution at the final time of a simulation can be retrieved.

Note, that simulation backward in time cannot be performed with an FMU, at least not across event times, because `fmiEventUpdate` can only compute the next discrete state, not the previous one.

2.10.Example

In the following example, the usage of the `fmiXXX` functions are sketched in order to clarify the typical calling sequence of the functions in a simulation environment. The example is given in a mix of pseudo-code and "C", in order to keep it small and understandable.

```

m = M_fmiInstantiateModel("m", ...) // "m" is the instance name
                                   // "M" is the MODEL_IDENTIFIER
nx      = ... // number of states, from xml file
nz      = ... // number of event indicators, from xml file
Tstart  = 0   // could also be retrieved from xml file
Tend    = 10  // could also be retrieved from xml file
dt      = 0.01 // fixed step size 10 milli-seconds

// set the start time
Tnext = Tend
time  = Tstart
M_fmiSetTime(m, time)

// set all variable start values (of "ScalarVariable / <type> / start") and
// set the input values at time = Tstart
M_fmiSetReal/Integer/Boolean/String(m, ...)

// initialize
M_fmiInitialize(m, fmiFalse, 0.0, &eventInfo)

// retrieve initial state x and
// nominal values of x (if absolute tolerance is needed)
M_fmiGetContinuousStates(m, x, nx)
M_fmiGetNominalContinuousStates(m, x_nominal, nx)

// retrieve solution at t=Tstart, e.g. for outputs
M_fmiGetReal/Integer/Boolean/String(m, ...)

```



```
while time < Tend and not eventInfo.terminateSimulation loop
  // compute derivatives
  M_fmiGetDerivatives(m, der_x, nx)

  // advance time
  h = min(dt, Tnext-time)
  time = time + h
  M_fmiSetTime(m, time)

  // set inputs at t = time
  M_fmiSetReal/Integer/Boolean/String(m, ...)

  // set states at t = time (perform one step)
  x = x + h*der_x // forward Euler method
  M_fmiSetContinuousStates(m, x, nx)

  // get event indicators at t = time
  M_fmiGetEventIndicators(m, z, nz)

  // inform the model about an accepted step
  M_fmiCompletedIntegratorStep(m, &callEventUpdate)

  // handle events, if any
  time_event = abs(time - Tnext) <= eps
  state_event = ... // compare sign of z with previous z
  if callEventUpdate or time_event or state_event then
    eventInfo.iterationConverged = fmiFalse

    while eventInfo.iterationConverged == fmiFalse loop //event iteration
      M_fmiEventUpdate(m, fmiTrue, &eventInfo)

      // retrieve solution at every event iteration
      if eventInfo.iterationConverged == fmiFalse then
        M_fmiGetReal/Integer/Boolean/String(m, ...)
      end if
    end while

    if eventInfo.stateValuesChanged == fmiTrue then
      //the model signals a value change of states, retrieve them
      M_fmiGetContinuousStates(m, x, nx)
    end if

    if eventInfo.stateValueReferencesChanged = fmiTrue then
      //the meaning of states has changed; retrieve new nominal values
      M_fmiGetNominalContinuousStates(m, x_nominal, nx)
    end if

    if eventInfo.upcomingTimeEvent then
      Tnext = min(eventInfo.nextEventTime, Tend)
    else
```



```
Tnext = Tend
end if
end if

// Retrieve solution at t=time, e.g. for outputs
M_fmiGetReal/Integer/Boolean/String(m, ...)
end while

// terminate simulation and retrieve final values
M_fmiTerminate(m)
M_fmiGetReal/Integer/Boolean/String(m, ...)

// cleanup
M_fmiFreeModelInstance(m)
```

Above, errors are not handled. Typically, fmiXXX function calls are performed in the following way:

```
status = M_fmiGetDerivatives(m, der_x, nx);
if ( status == fmiDiscard ) goto DISCARD; // reduce step size and try again
if ( status == fmiError ) goto ERROR; // cleanup and stop simulation
if ( status == fmiFatal ) goto FATAL; // stop using the model
```

These if-clauses could also be collected together in a macro to simplify the code.

3. Model Description Schema

All information related to a model, with exception of the model equations, are stored in a text file in xml format. Especially, the model variables and their attributes such as name, unit, default initial value etc. are stored in this file. The structure of all such xml files is defined with the schema file "fmiModelDescription.xsd". This schema file utilizes the following helper schema files:

```
fmiBaseUnit.xsd
fmiType.xsd
fmiScalarVariable.xsd
```

In this section the schema files are described. The normative definition are the above mentioned schema files⁶. Below, optional elements are marked with a "dashed" box. The required data types (like: xs:normalizedString) are defined in the xml-schema standard: <http://www.w3.org/TR/xmlschema-2/>. The types used in the fmi schema files are:

XML	Description (http://www.w3.org/TR/xmlschema-2/)	Mapping to C
xs:double	IEEE double-precision 64-bit floating point type	double
xs:int	Integer number with maximum value 2147483647 and minimum value -2147483648 (32 bit Integer)	int
xs:unsignedInt	Integer number with maximum value 4294967295 and minimum value 0 (unsigned 32 bit Integer)	unsigned int
xs:boolean	Boolean number. Legal literals: false, true, 0, 1	char
xs:string	Any number of characters	char*
xs:normalizedString	String without carriage return, line feed, and tab characters	char*
xs:dateTime	Date, time and time zone (for details see the link above). Example: 2002-10-23T12:00:00Z (noon on October 23, 2002, Greenwich Mean Time)	tool specific

The first line of an xml file must contain the encoding scheme of the xml-file, such as:

```
<?xml version="1.0" encoding="UTF-8"?>
```

A specific encoding scheme is not required by the fmi schema files. Typical schemes are "ISO-8859-1" or "UTF-8". The fmi schema files are stored in "UTF8". Note, the definition of an encoding scheme is a prerequisite, in order that the xml-file can contain letters outside of the 7 bit ANSI ASCII character set, such as German umlauts, or Asian characters. If another encoding scheme as "UTF-8" is used, then the non-ASCII characters in string variables need to be transformed to UTF8 when reading them from file, because the FMI calling interface requires that strings are encoded in UTF8.

⁶ Note, the screenshots of this section have been generated from the schema files with the tool "Altova XMLSpy" (www.altova.com). With the enterprise edition of XMLSpy it is possible to automatically generate C++, C# and Java code that reads an xml-file of fmiModelDescription.xsd.

3.1. Description of a Model (fmiModelDescription)

This is the root-level schema file and contains the following definition:

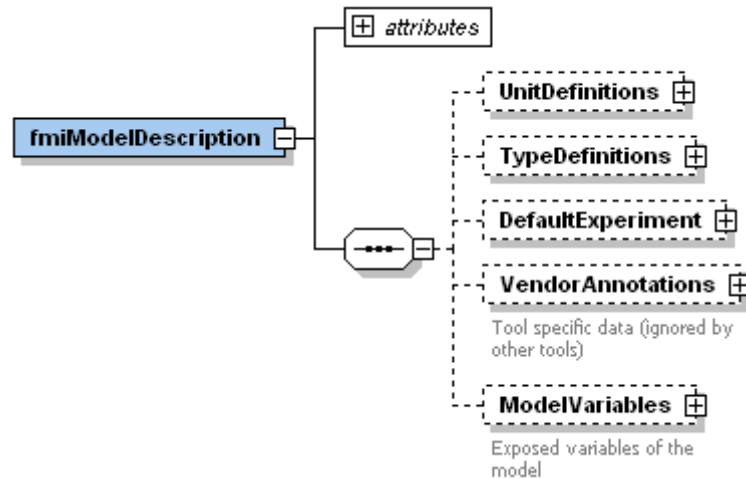

On the top level, the schema consists of

<i>Element-Name</i>	<i>Description</i>
attributes	The xml-attributes of fmiModelDescription define global properties of the model, such as the model name, see below.
UnitDefinitions	A global list of definitions to convert display units into the units used in the model equations. These definitions are used in the xml-element "ModelVariables".
TypeDefinitions	A global list of type definitions that are utilized in "ModelVariables".
DefaultExperiment	Providing default settings for the integrator, such as stop time and relative tolerance.
VendorAnnotations	Additional data that a vendor might want to store and that other vendors might ignore.
ModelVariables	The central FMI data structure defining all variables of the model that are visible/accessible via the model functions

The xml-attributes of fmiModelDescription are:

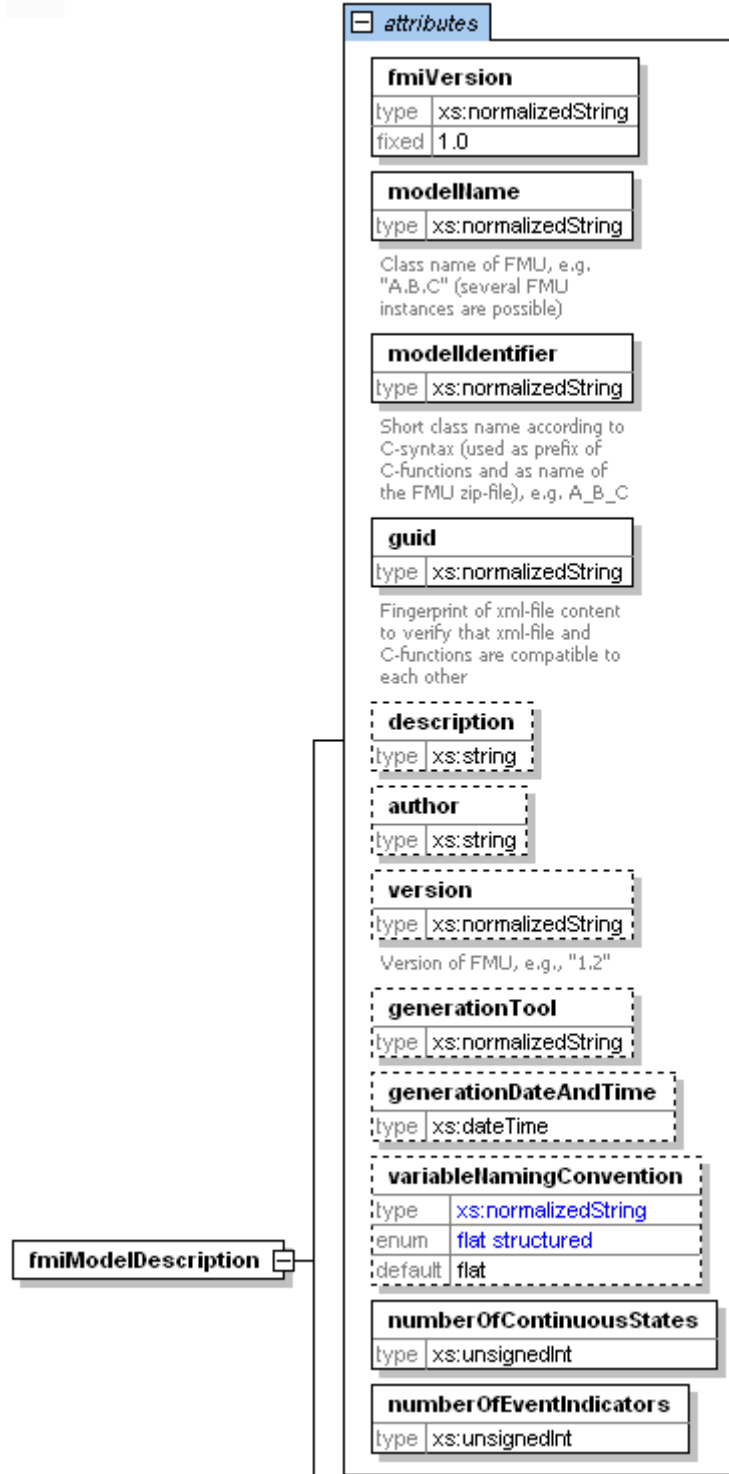

Attribute-Name	Description
fmiVersion	Version of "FMI for Model Exchange" that was used to generate the xml file. Currently, the only possible value is "1.0".
modelName	The name of the model as used in the modelling environment that generated the xml-file, such as "Modelica.Mechanics.Rotational.Examples.CoupledClutches".
modelIdentifier	String that is used as prefix in the C-function names of the model and as name of the zip-file in which all model information is stored. Since

	<p>this name is part of a C-function name, it must fulfil the restrictions on C function names (only letters, digits and/or underscores are allowed). For example, if <code>modelName = "A.B.C"</code>, then <code>modelIdentifier</code> might be <code>"A_B_C"</code>. Since <code>modelIdentifier</code> is used as name in a file system, it must also fulfil the restrictions of the targeted operating systems. Basically, this means that it should be <u>short</u>. For example, the Windows API only supports full path-names of a file up to 260 characters (see: http://msdn.microsoft.com/en-us/library/aa365247%28VS.85%29.aspx).</p>
<code>guid</code>	<p>The "Globally Unique Identifier" is a string that is used to check that the xml-file is compatible with the C-functions of the model. Typically when generating the xml-file, a fingerprint of the "relevant" information is stored as <code>guid</code> and in the generated C-function.</p>
<code>description</code>	String describing shortly the model
<code>author</code>	String with the name and organization of the model author
<code>version</code>	Version of the model, e.g. "1.0"
<code>generationTool</code>	Name of the tool that generated the xml-file.
<code>generationDateAndTime</code>	Date and time when the xml-file was generated. The format is a subset of "xs:dateTime" and should be: "YYYY-MM-DDThh:mm:ssZ" (with one "T" between date and time; "Z" characterizes the Zulu time zone, i.e., Greenwich meantime). Example: "2009-12-08T14:33:22Z".
<code>variableNamingConvention</code>	<p>Defines whether the variable names in "ModelVariables / ScalarVariable / name" and in "TypeDefinitions / Type / name" follow a particular convention. For the details, see Appendix B.1. Currently standardized are:</p> <ul style="list-style-type: none"> • "flat": A list of strings. • "structured": Hierarchical names with "." as hierarchy separator, and with array elements and derivative characterization.
<code>numberOfContinuousStates</code>	<p>The number of (fixed) continuous states. This number cannot be determined from the rest of the xml file and is therefore defined here. Note, the association of continuous states with variables can change dynamically during simulation, see Appendix B.3.</p>
<code>numberOfEventIndicators</code>	The number of (fixed) event indicators.

Element "**UnitDefinitions**" of `fmiModelDescription` is defined as:

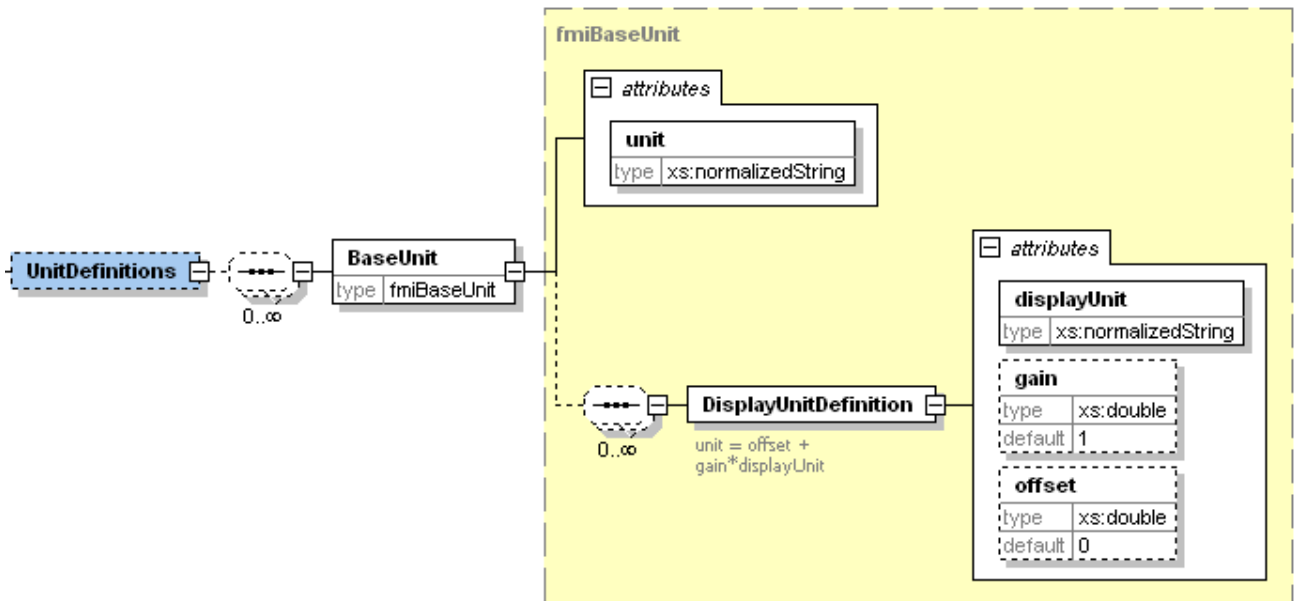

It consists of a set of base unit definitions (such as “<BaseUnit unit=“N.m”>) and for every base unit a set of displayUnits is defined together with the conversion to the base unit according to the equation:

$$\text{unit} = \text{gain} * \text{displayUnit} + \text{offset}$$

“offset” is, e.g., needed for temperature units. The displayUnit definitions are used in the ModelVariable element. Example for a definition:

```
<BaseUnit unit="rad/s">
  <DisplayUnitDefinition displayUnit="deg/s" gain=57.2957795130823/>
  <DisplayUnitDefinition displayUnit="r/min" gain=9.54929658551372/>
</BaseUnit>
```

The schema definition is present in a separate file “fmiBaseUnit.xsd”.

Element “**TypeDefinitions**” of fmiModelDescription is defined in section 3.2.

Element “**DefaultExperiment**” of fmiModelDescription is defined as:

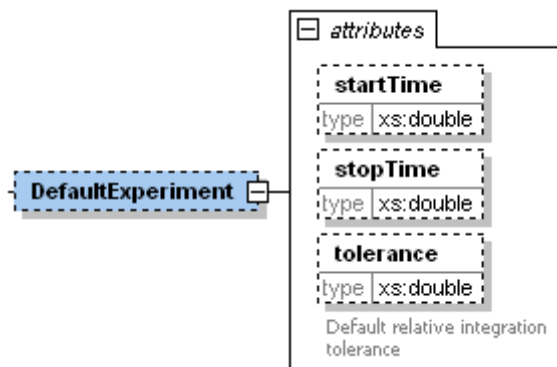

DefaultExperiment consists of the optional default start time, stop time and relative tolerance for the first simulation run. A tool may ignore this information. However, it is convenient for a user that startTime, stopTime and tolerance have already a meaningful default value for the model at hand.

Element “**VendorAnnotations**” of fmiModelDescription is defined as:

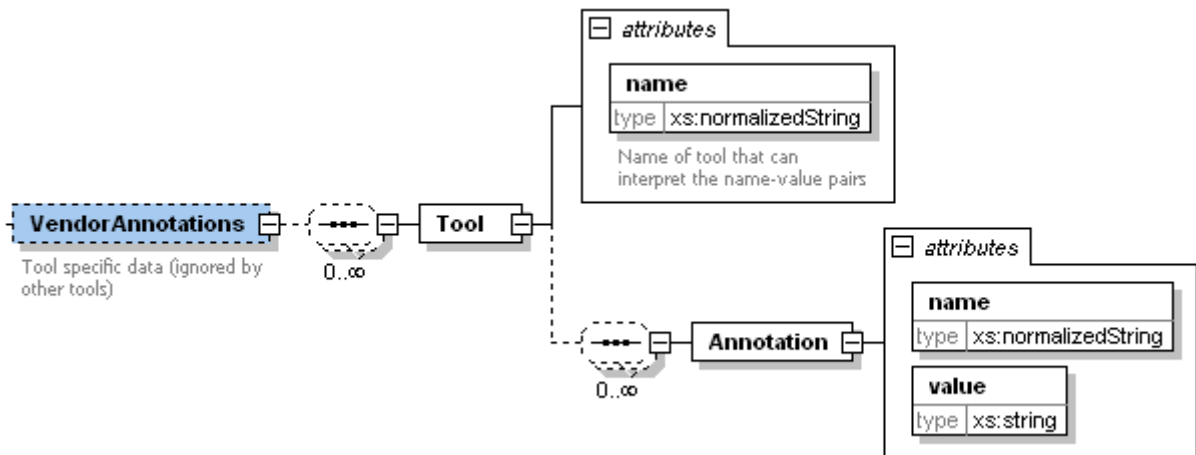

VendorAnnotations consist of a ordered set of annotations that are identified by Tool name and for every Tool name there is an ordered set of “name/value” pairs. It is expected that the information here is only interpreted by the respective tool and that other tools ignore the information.

3.2. Definition of a Type (fmiType)

Element “**TypeDefinitions**” of fmiModelDescription is defined as:

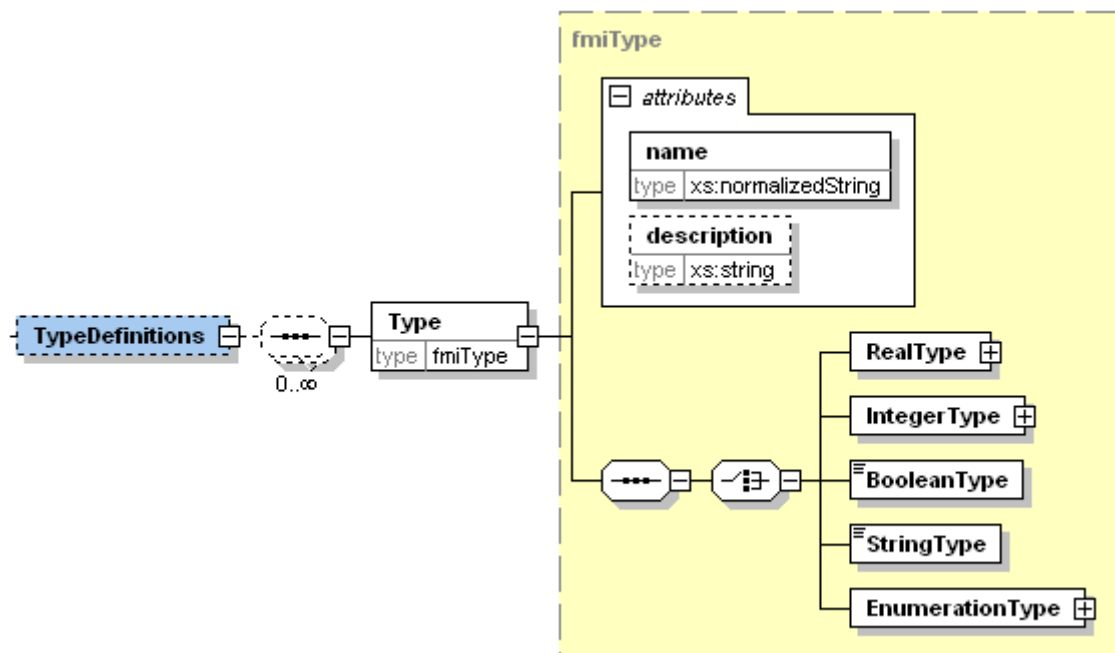

This element consists of a set of “Type” definitions according to schema file “fmiType.xsd”. One “Type” has a type “name” and “description as attributes and one of RealType, IntegerType, BooleanType, StringType or EnumerationType must be present. The latter have the following definitions:

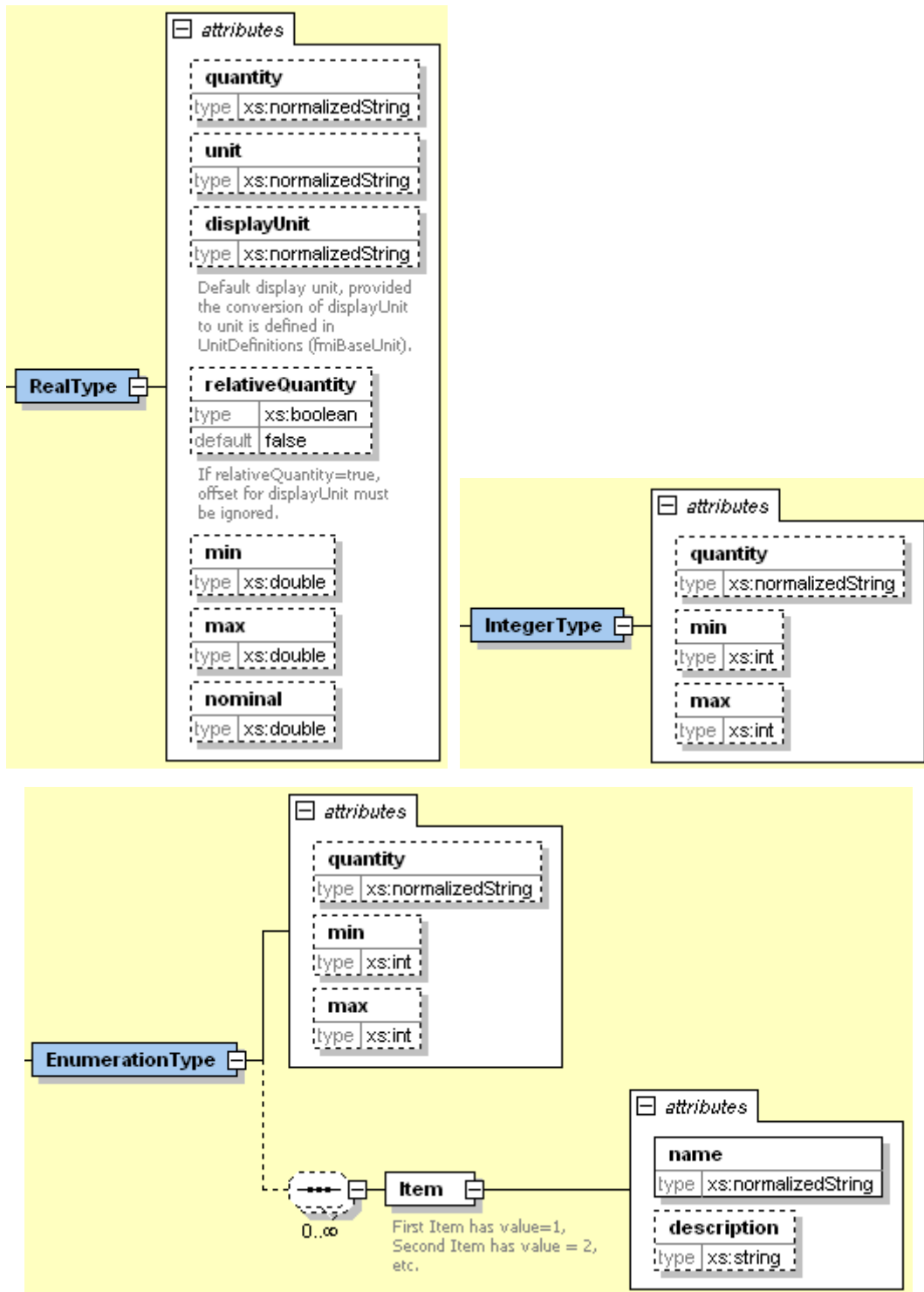

These definitions are used as default values in element ModelVariables, in order that, say, the definition of a “Torque” type does not have to be repeated over and over again. The attributes and elements have the following meaning:

Name	Description
quantity	Physical quantity of the variable, e.g., “Angle”, or “Energy”
unit	Unit of the variable that is used for the model equations, e.g., “N.m”.
displayUnit	Default display unit. The conversion to the “unit” is defined with the element

	“fmiModelDescription / UnitDefinitions”. If the corresponding “displayUnit” is not defined here, then “unit” is used for input/output and displayUnit is ignored.
relativeQuantity	If this attribute is true, then the “offset” of “displayUnit” must be ignored (e.g. 10 degree Celsius = 10 Kelvin if “relativeQuantity = true” and not 283 Kelvin).
min	Minimum value of variable (variable \geq min). If not defined, the minimum is the largest negative number that can be represented on the machine. Functions <code>fmiSetReal/fmiSetInteger</code> are not allowed to be called with a value that is less than the minimum value.
max	Maximum value of variable (variable \leq max). If not defined, the maximum is the largest positive number that can be represented on the machine. Functions <code>fmiSetReal/fmiSetInteger</code> are not allowed to be called with a value that is greater than the maximum value.
nominal	Nominal value of variable. If not defined and no other information about the nominal value is available, then nominal = 1 is assumed.
Item	Items of an enumeration as a sequence of “name” and “description” pairs. The first Item has Integer value = 1, the second 2 and so on.

3.3. Definition of a Scalar Variable (fmiScalarVariable)

Element “**ModelVariables**” of `fmiModelDescription` is the central part of the model description and is defined as:

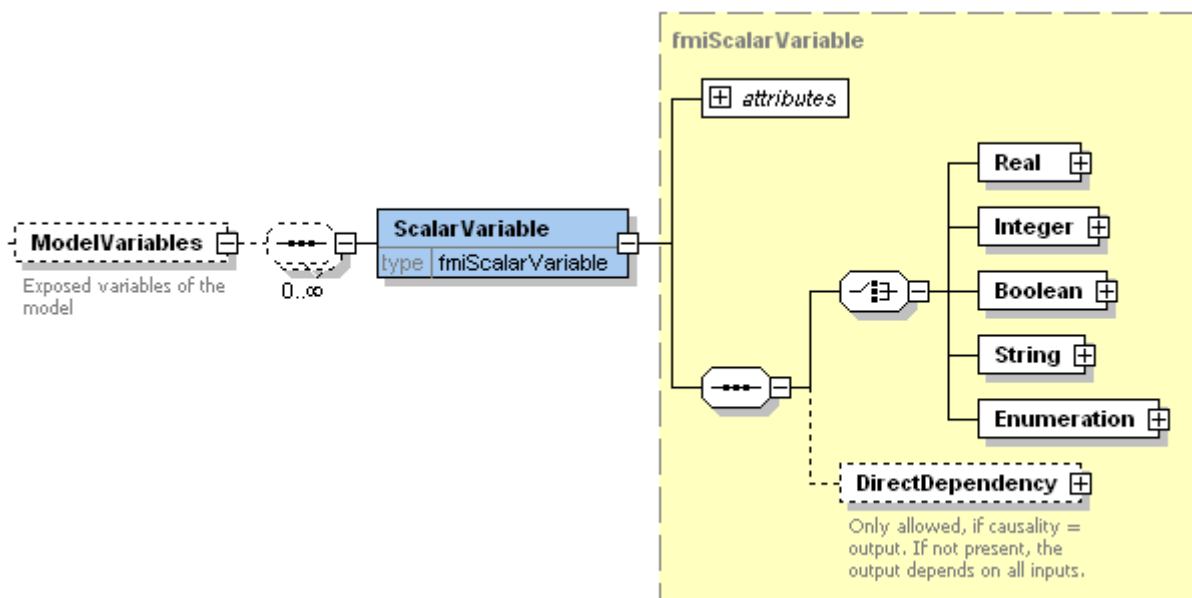

The optional “**ModelVariables**” element consists of an ordered set of “**ScalarVariable**” elements. A “**ScalarVariable**” represents one primitive type, like a real or integer variable. For simplicity, only scalar variables are supported in the schema file in this version and structured entities (like arrays or records) have to be mapped to scalars. The schema definition is present in a separate file “`fmiScalarVariable.xsd`”. The attributes of “**ScalarVariable**” are:

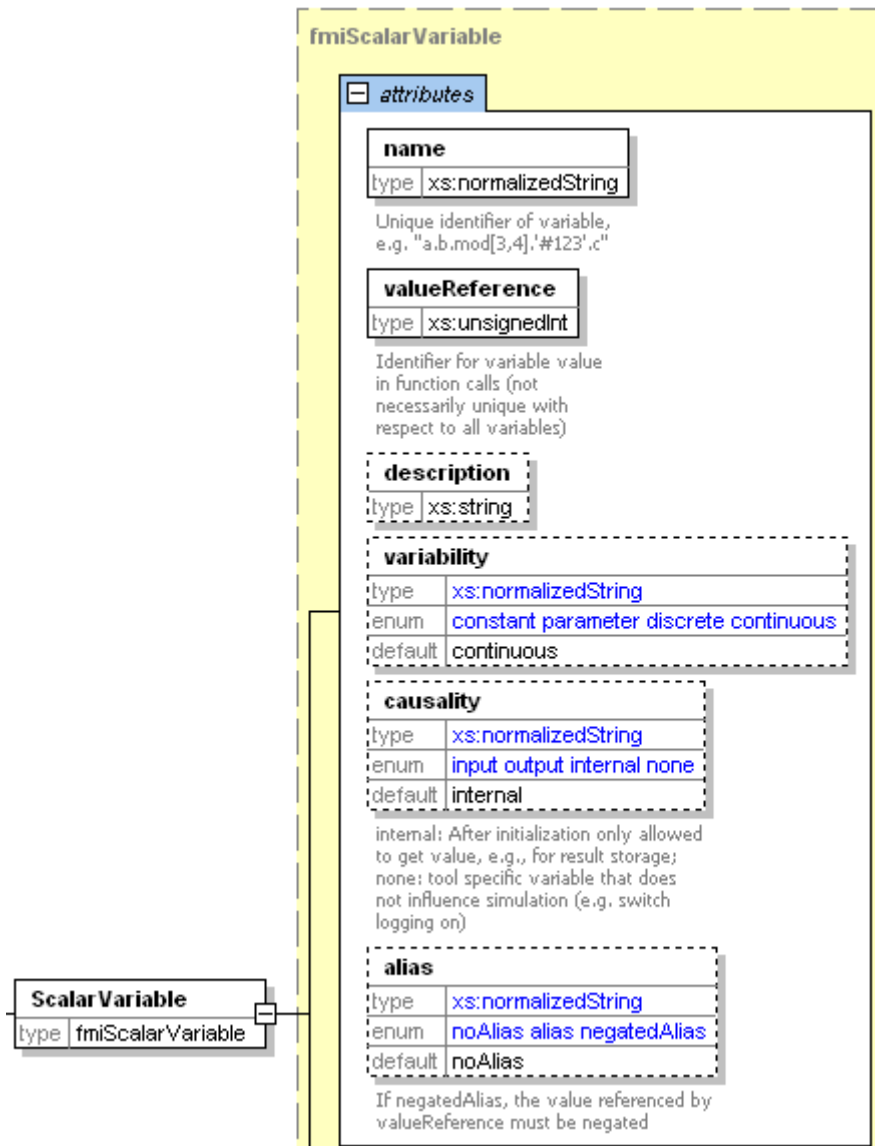

Attribute-Name	Description
name	The full, <u>unique name</u> of the variable. Every variable is uniquely identified within an FMU instance by this name.
valueReference	A handle of the variable to efficiently identify the variable value in the model interface. This handle is a secret of the environment that generated the C-functions. It is not required to be unique. The only guarantee is that <code>valueReference</code> is sufficient to identify the respective variable value in the call of the C-functions. This implies that it is unique for a particular base data type (Real, Integer/Enumeration, Boolean, String) with exception of alias variables (variables with <code>alias = "alias"</code> or <code>"negatedAlias"</code> have the same <code>valueReference</code> as the variable to which they are aliased).
description	An optional description string describing the meaning of the variable
variability	Defines when the value of the variable changes. The purpose of this attribute is to define when a result value needs to be inquired and to be stored (e.g., discrete variables change their values only at events instants and it is therefore only necessary to store them at event times). Allowed values of this enumeration: <ul style="list-style-type: none"> “constant”: The value of the variable is fixed and does not change.

	<ul style="list-style-type: none"> • “parameter”: The value of the variable does not change after initialization (the value is fixed after <code>fmiInitialize</code> was called). • “discrete”: The value of the variable only changes during initialization and at event instants. • “continuous”: No restrictions on value changes. Only a variable of type = “Real” can be “continuous”. <p>The default is “continuous”. Note, no information about continuous states is defined, with exception of the fixed number of states in “<code>fmiModelDescription / NumberOfContinuousStates</code>”. This information is sufficient in order that the equations can be solved. The reason is that (a) the meaning of states can change dynamically (see Appendix B.3) and then there is no fixed relationship to a variable, and (b) tools may not want to reveal the meaning of states, in order to protect know-how of the model.</p>
causality	<p>Defines how the variable is visible from the outside of the model. This information is needed when the FMU is connected to other FMUs. Allowed values of this enumeration:</p> <ul style="list-style-type: none"> • “input”: A value can be provided from the outside. Initially, the value is set to its “start” value (see below). • “output”: A value can be utilized in a connection • “internal”: After initialization only allowed to get value, e.g., to store the value as result. It is not allowed to use this value in a connection. Before initialization, start values can be set. • “none”: The variable does not influence the model equations. It is a tool specific variable to, e.g., switch certain logging or storage features on or off. Variables with this causality setting can be set with the <code>fmiSetXXX</code> functions at any time. <p>The default is “internal”.</p>
alias	<p>Enumeration that defines whether the respective variable is an alias variable. An alias variable is the result of an equation “$a := b$” or “$a := -b$”, where for efficiency reasons alias variable “a” is removed in the C-functions and is replaced by “b” or “-b” respectively (this situation occurs very often in models built-up by connecting physical components together). In order to retrieve the value of “a” from the value of “b”, the alias property is defined with this attribute and the <code>valueIdentifier</code> is the one from “b”.</p> <p>Allowed enumeration values:</p> <ul style="list-style-type: none"> • “noAlias”: It is not an alias variable (this is the default). • “alias”: The variable is an alias variable. The actual value can be set/get via the <code>valueReference</code> handle. • “negatedAlias”: The variable is an alias variable where the variable value retrieved via the <code>valueReference</code> handle must be negated (the C-functions return the value of “b” and then “$a := -b$”). <p>When storing results, the alias property should be taken into account in order to decrease significantly the size of the result file.</p>

Type specific properties are defined in the required choice element, where exactly one of “Real”, “Integer”, “Boolean”, “String” or “Enumeration” must be present in the xml-file:

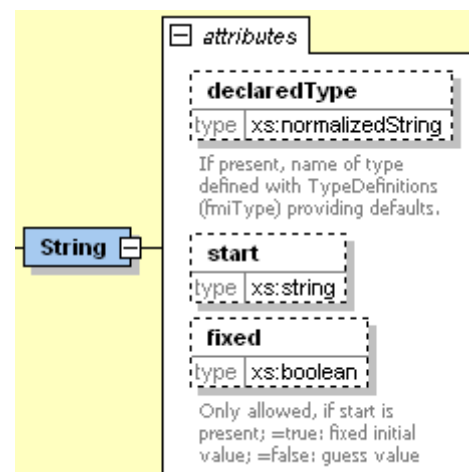
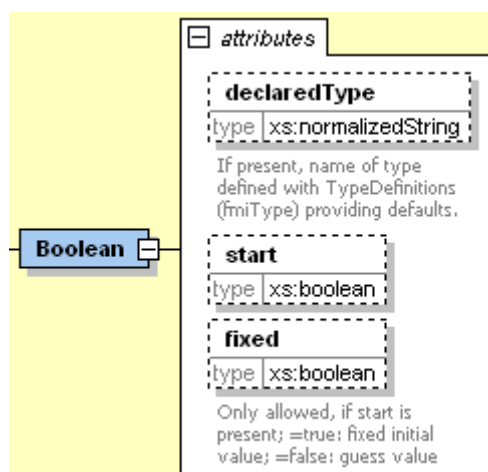
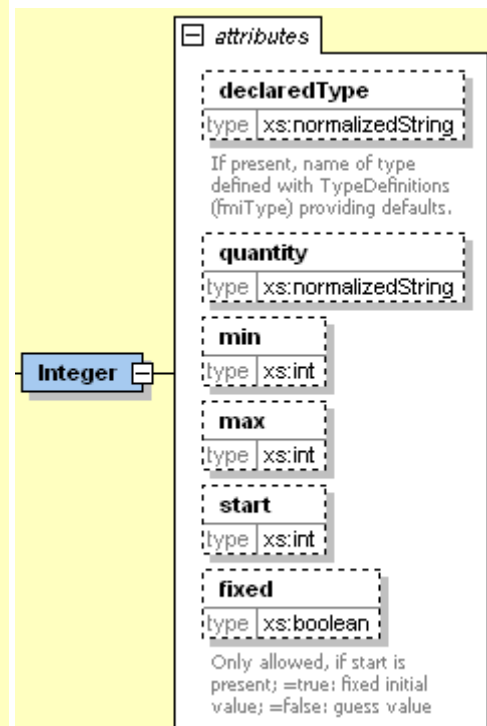
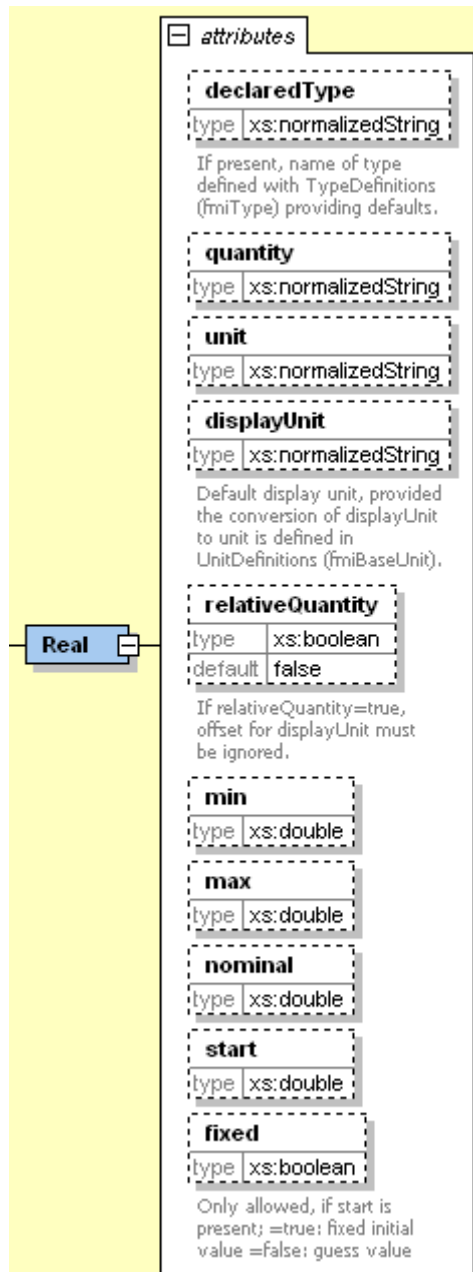

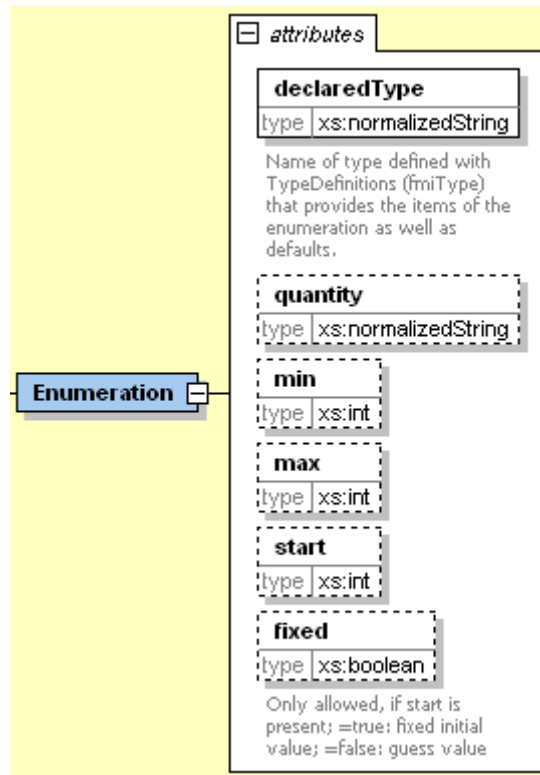

The attributes are defined in section 3.2, except:

Attribute-Name	Description
declaredType	If present, name of type defined with TypeDefinitions (fmiType). The values defined in the corresponding TypeDefinition (see section 3.2) are used as default. If, e.g., "min" is present both in RealType (of TypeDefinition) and in "Real" (of ScalarVariable), then the "min" of ScalarVariable is actually used. For Real, Integer, Boolean, String, this attribute is optional. For Enumeration it is required, because the Enumeration items are defined in TypeDefinitions.
start	Initial value of variable. This value is also stored in the C-functions. A different start value can be provided with a <code>fmiSetXXX</code> function before <code>fmiInitialize</code> is called (but not for "constant" variables). A variable of causality = "input", must have a "start" value. This start value is used by the model as value of the input, if the input is not set by the environment. Note, all constants, independent parameters and inputs of the FMU must have a start value in the xml-file. Parameters that do not have a start value are computed during initialization (e.g. as functions of other parameters).
fixed	Defines the meaning of attribute "start", if "causality" is not "input". This attribute is only allowed if "start" is also present: <ul style="list-style-type: none"> = <i>true</i>: "start" is an initial value of a variable, i.e., after calling function <code>fmiInitialize</code> (section 2.7), the variable has this value (at least up to a certain numerical precision). This is the default. = <i>false</i>: "start" is a guess value. The variable is used as iteration variable during initialization. After initialization, the variable can have a different value as "start".

Finally, element "DirectDependency" defines the dependency of an output from its inputs:

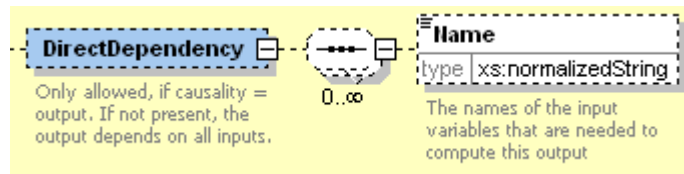

“DirectDependency” is only allowed for variables with causality = “output”. If not present, then the output variable depends directly on all input variables. If present, the output variable depends directly only on the listed input variables (i.e., variables with causality = “input”) which are needed to compute this output. This information is used when FMUs are connected together, for details see Appendix B.5.

3.4. Example

When generating an FMU from the model “Modelica.Mechanics.Rotational.Examples.Friction” of the Modelica Standard Library (www.modelica.org/libraries/Modelica), the xml-file may have the following content:

```
<?xml version="1.0" encoding="UTF8"?>
<fmiModelDescription
  fmiVersion="1.0"
  modelName="Modelica.Mechanics.Rotational.Examples.Friction"
  modelIdentifier="Modelica_Mechanics_Rotational_Examples_Friction"
  guid="{8c4e810f-3df3-4a00-8276-176fa3c9f9e0}"
  description="Drive train with clutch and brake"
  version="3.1"
  generationTool="Dymola Version 7.4, 2010-01-25"
  generationDateAndTime="2009-12-22T16:57:33Z"
  variableNamingConvention="structured"
  numberOfContinuousStates="6"
  numberOfEventIndicators="34">

  <UnitDefinitions>
    <BaseUnit unit="rad">
      <DisplayUnitDefinition displayUnit="deg" gain="57.2957795130823"/>
    </BaseUnit>
  </UnitDefinitions>

  <TypeDefinitions>
    <Type name="Modelica.SIunits.Torque">
      <RealType quantity="MomentOfInertia" unit="kg.m2" min="0.0"/>
    </Type>
    <Type name="Modelica.SIunits.AngularVelocity">
      <RealType quantity="AngularVelocity" unit="rad/s"/>
    </Type>
  </TypeDefinitions>

  <DefaultExperiment startTime="0.0" stopTime="3.0" tolerance="0.0001"/>

  <ModelVariables>
    <ScalarVariable
      name="inertial.J"
      valueReference="16777217"
      description="Moment of inertia"
      variability="parameter">
      <Real declaredType="Modelica.SIunits.Torque" start="1"/>
    </ScalarVariable>
```



```
<ScalarVariable
  name="inertial.w"
  valueReference="33554433"
  description="Absolute angular velocity of component (= der(phi))">
  <Real declaredType="Modelica.SIunits.AngularVelocity" start="100"/>
</ScalarVariable>

...
</ModelVariables>
</fmiModelDescription>
```

4. Model Distribution

A FMU description consists of several files. A FMU may be distributed in textual and/or in binary format. All relevant files are stored in a zip-file with a pre-defined structure. The name of the zip-file must be identical to the “modelIdentifier” stored as xml-attribute in the Model Description File and used as defined symbol MODEL_IDENTIFIER (see page 9) with header file “fmiModelFunctions.h”. The extension of the zip-file must be “.fmu”, e.g., “HybridVehicle.fmu”. The compression method used for the zip-file must be “deflate” (most free tools, e.g. zlib, offer only the common compression method “deflate”).

Every FMU is distributed by its own zip-file. This zip-file has the following structure:

```
// Structure of zip-file of an FMU
modelDescription.xml      // Description of model (required file)
model.png                // Optional image file of model icon
documentation           // Optional directory containing the model documentation
  _main.html              // Entry point of the documentation
  <other documentation files>
sources                  // Optional directory containing all C-sources
  // all needed C-sources and C-header files to compile and link the model
  // with exception of: fmiModelTypes.h and fmiModelFunctions.h
binaries                 // Optional directory containing the binaries
  win32 // Optional binaries for 32-bit Windows
    <modelIdentifier>.dll // DLL of the model interface implementation

  // Optional object Libraries for a particular compiler
  VisualStudio8          // Binaries for 32-bit Windows generated with
                          // Microsoft Visual Studio 8 (2005)
    <modelIdentifier>.lib // Binary libraries
  gcc3.1                 // Binaries for gcc 3.1.
  ...
  win64 // Optional binaries for 64-bit Windows
  ...
  linux32 // Optional binaries for 32-bit Linux
  ...
  linux64 // Optional binaries for 64-bit Linux
  ...
resources // Optional resources needed by the model
  < data in model specific files which will be read during initialization >
```

The model must be distributed with at least one Model Interface implementation, i.e., either sources or one of the binaries for a particular machine. It is also possible to provide the sources and binaries for different target machines altogether in one zip-file. The names “win32”, “win64”, “linux32”, “linux64” are standardized, as well as the names “VisualStudioX” and “gccX” that define the compiler with which the binary has been generated. Further names can be introduced by vendors. Typical scenarios are to provide binaries only for one machine type (e.g. on the machine where the target simulator is running and for which licenses of run-time libraries are available) or to provide only sources (e.g. for translation and download for a particular micro-processor). If run-time libraries cannot be shipped due to licensing, special handling is needed, e.g., by providing the run-time libraries at appropriate places by the receiver.

In directory “resources”, additional data can be provided in model specific formats, typically for tables and maps used in the model. This data must be read into the model at latest during initialization (“fmiInitialize”). The actual file names in the zip-file to access the data files can either be hard-coded in the generated model functions, or the file names can be provided as string parameters via the “fmiSetString” function.

Note, the header files `fmiModelTypes.h` and `fmiModelFunctions.h` are not included in the FMU due to the following reasons:

- `fmiModelTypes.h` makes no sense in the “`sources`” directory, because if sources are provided, then the target simulator defines this header file and not the FMU.
This header file is not included in the “`binaries`” directory, because it is implicitly defined by the platform directory (e.g. `win32` for 32-bit machine or `linux64` for 64-bit machine). Furthermore, the version that was used to construct the FMU can also be inquired via function `fmiGetModelTypesPlatform()`.
- `fmiModelFunctions.h` is not needed in the “`sources`” directory, because it is implicitly defined by attribute `fmiVersion` in file `modelDescription.xml`. Furthermore, in order that the C-compiler can check for consistent function arguments, the header file from the target simulator should be used when compiling the C-sources. It would therefore be counter productive (unsafe), if this header file would be present.
This header file is not included in the “`binaries`” directory, since this header file was already utilized to build the target simulator executable. Via attribute `fmiVersion` in file `modelDescription.xml` or via function call `fmiGetVersion()` the version number of this header file used to construct the FMU can be deduced.

5. Literature

AMESim: www.lmsintl.com/

AUTOSAR: www.autosar.org.

Blochwitz T., Kurzbach G., Neidhold T. (2008): **An External Model Interface for Modelica**. 6-th International Modelica Conference, Bielefeld 2008.

www.modelica.org/events/modelica2008/Proceedings/sessions/session5f.pdf

Dymola: www.dynasim.se.

Elmqvist (1978): **A Structured Model Language for Large Continuous Systems**. PhD Dissertation, Lund Institute of Technology. CODEN: LUTFD2/(TFRT-1015)/1-226/(1978).

www.control.lth.se/database/publications/article.pike?artkey=elm78dis

EXITE: www.extessy.com

Modelica (2009): **Modelica, A Unified Object-Oriented Language for Physical Systems Modelling. Language Specification, Version 3.1**. May 27th, 2009.

www.modelica.org/documents/ModelicaSpec31.pdf

MODELISAR Glossary (2009): **MODELISAR WP2 Glossary and Abbreviations**. Version 1.0, June 9, 2009.

Otter M. (1999): **Objektorientierte Modellierung Physikalischer Systeme, Teil 4**. at – Automatisierungstechnik, April, pp. A13-A16.

Otter M., Elmqvist H. (1995): **The DSblock model interface for exchanging model components**. Proceedings of EUROSIM '95 Simulation Congress, pp. 505-510, Sept. 11-15, Vienna.

Silver: www.qtronic.de/de/silver.html

Simpack: www.simpack.com

SimulationX: www.simulationx.com.

Tarjan R.E. (1972): **Depth First Search and Linear Graph Algorithms**. SIAM J. Comp., 1, pp. 146-160.

XML: www.w3.org/XML, en.wikipedia.org/wiki/XML

Appendix A Contributors

A.1 Version 1.0

The Functional Mock-up Interface subproject inside MODELISAR was initiated and organized by Daimler AG. The development of version 1.0 was performed within WP200 of the MODELISAR ITEA2 project, organized by the WP200 work package leader Dietmar Neumerkel (Daimler). The subgroup “FMI for Model Exchange” was headed by Martin Otter (DLR-RM). The essential part of the design of this version was performed by (alphabetical list):

Torsten Blochwitz, ITI, Germany
Hilding Elmqvist, Dassault Systèmes (Dynasim), Sweden
Andreas Junghanns, QTronic, Germany
Jakob Mauss, QTronic, Germany
Hans Olsson, Dassault Systèmes (Dynasim), Sweden
Martin Otter, DLR-RM, Germany.

This version was evaluated with prototypes implemented for (alphabetical list):

Dymola by Peter Nilsson, Dan Henriksson, Carl Fredrik Abelson, and Sven Erik Mattson,
Dassault Systèmes (Dynasim),
JModelica.org by Tove Bergdahl, Modelon AB,
Silver by Andreas Junghanns, and Jakob Mauss, QTronic.

These prototypes have been used to refine the design of “FMI for Model Exchange”.

The following MODELISAR partners participated at FMI design meetings and contributed to the discussion (alphabetical list):

Ingrid Bausch-Gall, Bausch-Gall GmbH, Munich, Germany
Torsten Blochwitz, ITI GmbH, Dresden, Germany
Alex Eichberger, SIMPACK AG, Gilching, Germany
Hilding Elmqvist, Dassault Systèmes (Dynasim), Lund, Sweden
Andreas Junghanns, QTronic GmbH, Berlin, Germany
Rainer Keppler, SIMPACK AG, Gilching, Germany
Gerd Kurzbach, ITI GmbH, Dresden, Germany
Carsten Kübler, TWT, Germany
Jakob Mauss, QTronic GmbH, Berlin, Germany
Johannes Mezger, TWT, Germany
Thomas Neidhold, ITI GmbH, Dresden, Germany
Dietmar Neumerkel, Daimler AG, Stuttgart, Germany
Peter Nilsson, Dassault Systèmes (Dynasim), Lund, Sweden
Hans Olsson, Dassault Systèmes (Dynasim), Lund, Sweden
Martin Otter, German Aerospace Center (DLR), Oberpfaffenhofen, Germany
Antoine Viel, LMS International (Imagine), Roanne, France
Daniel Weil, Dassault Systèmes, Grenoble, France

The following people outside of the MODELISAR consortium contributed with comments:

Johan Akesson, Lund University, Lund, Sweden
Joel Andersson, KU Leuven, The Netherlands
Roberto Parrotto, Politecnico di Milano, Italy

Appendix B Implementation Issues

In this section some details to implement the Model Exchange Interface are discussed.

B.1 Variable Naming Conventions

With attribute “variableNamingConvention” of element “fmiModelDescription”, the convention is defined how the ScalarVariable.names have been constructed. If this information is known, the environment may be able to represent the names in a better way (e.g. as tree and not as a linear list).

In the following definitions, the [EBNF](#) is used:

```
= production rule
[ ] optional
{ } repeat zero or more times
| or
```

The following conventions for scalar names are defined:

variableNamingConvention = “flat”

```
name = any member of the source character set // no hierarchy
```

The names are an ordered set that might be represented in a drop down menu as a list of strings.

variableNamingConvention = “structured”

Structured names are hierarchical using “.” as a separator between hierarchies. A name consists of “_”, letters and digits or may consist of any characters enclosed in single apostrophes. A name may identify an array element on every hierarchical level using “[...]” to identify the respective array index. A derivative of a variable is defined with “der (name)” for the first time derivative and “der (name, N)” for the N-th derivative. Examples:

```
vehicle.engine.speed
resistor12.u
v_min
robot.axis.'motor #234'
der(pipe[3,4].T[14],2) // second time derivative of pipe[3,4].T[14]
```

The precise syntax is:

```
name           = identifier | "der(" identifier [, unsignedInteger ] ")"
identifier      = B-name [ arrayIndices ] { "." B-name [ arrayIndices ] }
B-name         = nondigit { digit | nondigit } | Q-name
nondigit       = "_" | letters "a" to "z" | letters "A" to "Z"
digit          = "0" | "1" | "2" | "3" | "4" | "5" | "6" | "7" | "8" | "9"
Q-name         = "'" ( Q-char | escape ) { Q-char | escape } "'"
Q-char         = any member of the source character set except
                single-quote "'", and backslash "\"
escape         = "\" | "\"" | "?" | "\\\" | "\a" | "\b" |
                "\f" | "\n" | "\r" | "\t" | "\v"
arrayIndices   = "[" unsignedInteger { , unsignedInteger } "]"
unsignedInteger = digit { digit }
```

The tree of names is mapped to an ordered list of ScalarVariable.name’s in [depth-first](#) order. Example:

```
vehicle
  transmission
```

```
ratio
outputSpeed
engine
inputSpeed
temperature
```

is mapped to the following list of `ScalarVariable.name`'s:

```
vehicle.transmission.ratio
vehicle.transmission.outputSpeed
vehicle.engine.inputSpeed
vehicle.engine.temperature
```

All array elements are given in a consecutive sequence of `ScalarVariables`. For example, the vector “centerOfMass” in body “arm1” is mapped to the following `ScalarVariables`:

```
robot.arm1.centerOfMass[1]
robot.arm1.centerOfMass[2]
robot.arm2.centerOfMass[3]
```

It might be that not all elements of an array are present. If they are present, they are given in consecutive order in the xml file.

B.2 Event Detection

An event is always triggered from the environment in which the FMU is called (so it is not triggered inside the FMU). Typically, this is performed in the following:

1. The integration period is limited by the time event $T_{next}(t_{i-1})$ defined at the last event instant t_{i-1} (return argument `eventInfo.nextEventTime` of `fmiEventUpdate`), so the integrator integrates from the previous event instant at most up to $t = T_{next}(t_{i-1})$. The integration step is thereby adapted for the last step, so that it reaches T_{next} exactly. If T_{next} is reached, an event is triggered, i.e., `fmiEventUpdate` is called.
2. The event indicators $z_j(t)$ are inspected after every completed integrator step. When the domain of z_j at this time instant is different to the domain from the last completed integrator step, an iteration procedure is started to find the time instant t_i (up to a certain precision), at which the domain is changing. Then, an event is triggered, i.e., `fmiEventUpdate` is called.
3. At every completed integrator step, `fmiCompletedIntegratorStep` is called. When this function returns with `callEventUpdate = fmiTrue`, an event is triggered, i.e., function `fmiEventUpdate` is called.

It can happen that the conditions above lead to event times that are close together. Assume that n potential event time instants $t_1, t_2, t_3, \dots, t_n$ (with $t_1 \leq t_2 \leq t_3 \leq \dots \leq t_n$) are determined according to these conditions (e.g., due to a time event, a step event, and domain changes of several event indicators) and that these time instants are close together, e.g. $t_n - t_1 \leq 100 \cdot \varepsilon$ (where ε is the machine precision, which is typically in the order of 10^{-16}). For efficiency reasons it is then usually best to only trigger one event at $t = t_n$. Whether this is performed and if yes, which time range is used, is specific to the respective simulation environment where the model is used.

State event detection leads to particular difficulties. One issue is that available integrators define state events by the “zero crossing” of variables, whereas the Model Exchange Interface defines state events by “domain changes”. The difference is that the “zero crossing” approach requires, that the event indicator variables are non-zero after initialization and after restart of an event. However, this condition cannot be guaranteed by a model. A related issue is that event handling may change the way a model is computed, e.g., solving different linear equation systems before and after an event, as it is the case for friction elements

or ideal switches. As a result, there can be numerical errors in the event indicators leading to the situation that, e.g., $z > 0$ before the event occurred and z crosses the domain, so that $z \leq 0$ at the event instant. Due to the changed model equations and numerical errors, z might change to $z > 0$, but when restarting the integration the physics is such that again a domain change to $z \leq 0$ takes place. So, a large number of events will occur. Also more complicated situations can occur that lead to event “chattering” and that might be treated in the FMU.

Some of the issues can be fixed by introducing hysteresis to the event indicators. The solution strategy is sketched in Figure 5:

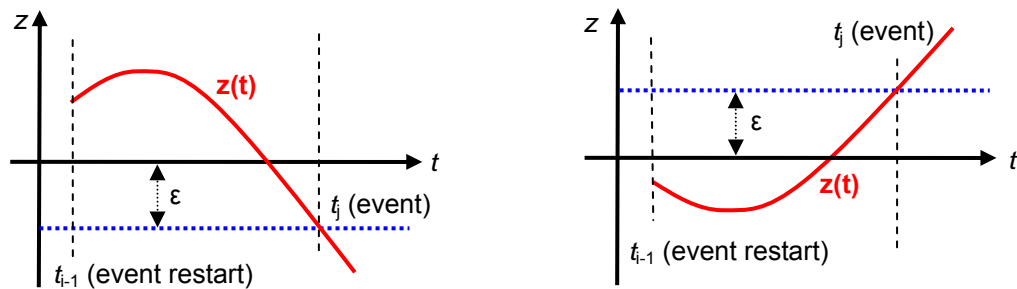

Figure 5: Introducing hysteresis for an event indicator z .

The FMU shall add or subtract a small value ϵ to an event indicator z , thereby (1) the zero crossing function is non-zero at the integration restart, and (2) hysteresis for the event detection is added. The precise definition is given in the following table:

<i>domain at restart</i>	<i>crossing function</i>	<i>event when</i>
$z > 0$	$z + \epsilon$	$z \leq -\epsilon$
$z \leq 0$	$z - \epsilon$	$z \geq +\epsilon$

There are several reasons why this change shall be made in the FMU and not in the environment that calls the FMU:

- Also more complicated situations can occur (“chattering”) that requires more information which can be provided by the tool that generated the FMU, but cannot be handled efficiently in the simulation environment that calls the FMU.
- The interface would become more complicated, because, e.g., the “nominal” value of z has to be reported by the FMU, in order to determine the size of ϵ in the environment.
- If this would be handled in the simulation environment, there is always the danger that the environment does not handle it properly, but the FMU would be blamed for a failure.

Note, the size of the small value ϵ shall be related to the size of z_j , e.g.:

$$z_{j,new} = \frac{z_j}{z_{j,nominal}} \pm \epsilon; \quad \epsilon = 0.0001 \cdot relativeTolerance$$

This means that the event indicator $z_{j,new}$ reported to the environment is the actual event indicator divided by its nominal value and adding or subtracting a small value, and the small value is a fraction of the relativeTolerance reported with function `fmiInitialize`. A nominal value for the event indicator can often be deduced by the modelling environment, otherwise it is set to one. For example, a relation $p_1 > p_2$, where p_i are pressures with a nominal value of 10^5 , would lead to an event indicator function:

$$z = p_1 - p_2, \quad z_{new} = \frac{p_1 - p_2}{10^5} \pm \epsilon$$

Assume that $z_{new} > 0$ at the event restart. Then an event occurs when $(p_1 - p_2)/10^5 \leq -\epsilon$, i.e.,

$$\frac{p_1 - p_2}{10^5} \leq -0.0001 \cdot \text{relativeTolerance} \rightarrow p_1 - p_2 \leq -10 \cdot \text{relativeTolerance}$$

For example, if $\text{relativeTolerance} = 10^{-4}$, an event would occur if $p_1 - p_2 \leq -10^{-3}$ which is a reasonable value to detect the domain change of a pressure difference.

B.3 Dynamic State Selection

In this version of the Model Exchange interface the number of continuous states is fixed and does not change during simulation. However, the meaning of the continuous states can change dynamically during simulation and can be either associated with other externally visible variables or with internal variables of the model at an event instant. A very simple example of this kind is given in Figure 6

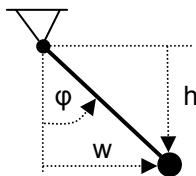

Figure 6: Dynamic state selection with step events:

The simple pendulum can be described by states φ , w , or h . If a model chooses to use $x = [w]$ as state, the differential equation becomes singular if $\varphi = \pm 90^\circ$. In the vicinity of this singular point, the model must change the state, e.g., to $x = [h]$. This can be achieved by a step event (this is more efficient than a state event, since no search process is needed to precisely detect the change of a domain).

Dynamic state selection typically occurs when a higher index differential algebraic equation is index reduced and an index 0 or 1 solver is used for the solution. Whenever the constraints between potential continuous states is non-linear, the states must be dynamically determined during simulation and therefore the meaning of states can change at event instants.

A consequence of this situation is that variables from the xml file cannot be associated with continuous states and therefore only the number of continuous states is defined in the xml-file. After every event, the actual association of the continuous states with model variables can be inquired with function `fmiGetStateValueReferences` provided the association is made with an externally visible variable and the generation tool does not want to hide this information.

B.4 Variable Caching

In section 2.6, the technique for variable caching is defined. In the table below, a simple example for caching is given to demonstrate that this technique is important for efficient model evaluation. It is also sketched how caching can be implemented for this example.

The model equations, see left column of the table, consist of an algebraic system of equations to compute y, \dot{x}_1 and an explicit equation to compute \dot{x}_2 . A straightforward but inefficient solution is shown in the right top part of the table: The basic functions are directly implemented, so there is a function to compute y and a function to compute \dot{x}_1, \dot{x}_2 . Since the algebraic system of equations must be solved for y and \dot{x}_1 , this equation system must be solved in both functions. When the outputs are connected to other submodels, the two functions must be called at the same time instants and therefore the equation system is always solved twice.

In the lower right part the recommended, efficient solution is shown: All functions in which model equations are executed, do not have any equations, but instead call the same internal function `fint(..)`, in which all equations of the model are present. The different parts of the model equations can be activated/deactivated via if-clauses. Now it is possible to mark that the algebraic system of equations was

already calculated, once $f_y(\dots)$ was called and just reuse the computed value of \dot{x}_1 if function $f_x(\dots)$ is called, without re-evaluating the equation system.

Simple example for caching		
Model equations: input: x_1, x_2 output: y, \dot{x}_1, \dot{x}_2 $0 = f_1(\dot{x}_1, x_1, y)$ $0 = f_2(\dot{x}_1, x_1, y)$ $\dot{x}_2 = f_3(x_1, x_2, y)$	Unefficient solution (algebraic system of equations is solved twice)	
	$\mathbf{y} = \mathbf{f}_y(\mathbf{x}, \mathbf{m}, \mathbf{u}, \mathbf{p}, t)$	$0 = f_1(\dot{x}_1, x_1, y)$ $0 = f_2(\dot{x}_1, x_1, y)$ // solve for y, \dot{x}_1 and return y
	$\dot{\mathbf{x}} = \mathbf{f}_x(\mathbf{x}, \mathbf{m}, \mathbf{u}, \mathbf{p}, t)$	$0 = f_1(\dot{x}_1, x_1, y)$ $0 = f_2(\dot{x}_1, x_1, y)$ // solve for y, \dot{x}_1, \dot{x}_2 and return \dot{x}_1, \dot{x}_2 $\dot{x}_2 = f_3(x_1, x_2, y)$
	Efficient solution with caching	
$\mathbf{y} = \mathbf{f}_y(\mathbf{x}, \mathbf{m}, \mathbf{u}, \mathbf{p}, t)$ → call $\mathbf{f}_{\text{int}}(\dots, \text{compute_y})$	<pre> function fmiSetContinuousStates(..) ... y_computed = false xd_computed = false function f_{int} if (compute_y or compute_xd) and not y_computed then 0 = f₁(\dot{x}_1, x_1, y) 0 = f₂(\dot{x}_1, x_1, y) // solve for y, \dot{x}_1 y_computed = true; end if; if compute_xd then $\dot{x}_2 = f_3(x_1, x_2, y)$ // compute \dot{x}_2 xd_computed = true end if; </pre>	
$\dot{\mathbf{x}} = \mathbf{f}_x(\mathbf{x}, \mathbf{m}, \mathbf{u}, \mathbf{p}, t)$ → call $\mathbf{f}_{\text{int}}(\dots, \text{compute_xd})$		

B.5 Connecting FMUs together

FMUs can be connected together hierarchically via their input and output variables, i.e., variables with `ScalarVariable.causality = "input"` or `"output"`. A typical example is shown in Figure 7 where three FMU instances A, B, and C are connected together.

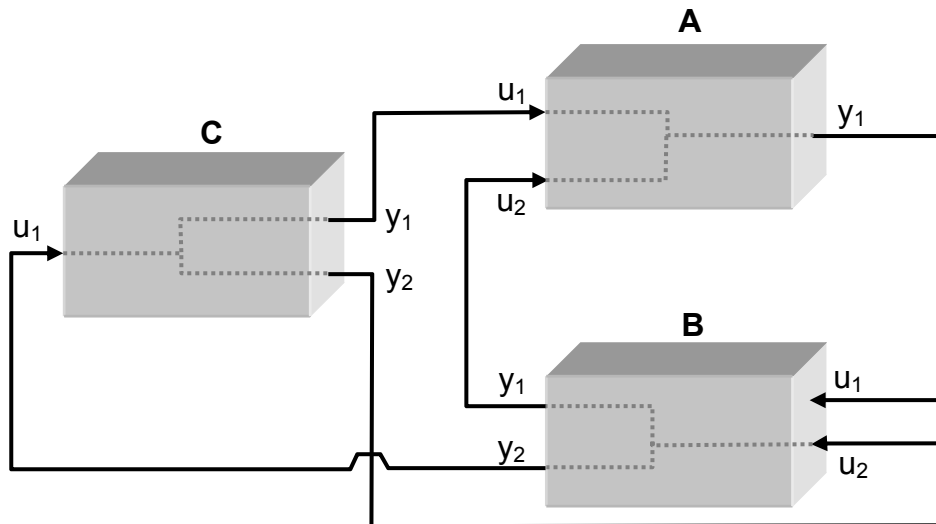

Figure 7: Example of three connected FMU instances.

In order that the model equations of the connected FMUs can be constructed efficiently, element “directDependency” in “ScalarVariable” (see section 3.3) defines the direct dependency of every output variable from its input variables. In many cases, models of physical systems do not have a direct dependency from their inputs and then connected FMUs do not lead to additional algebraic equation systems. Still, it is often non-trivial to determine the correct evaluation sequence of `fmiSetXXX` and `fmiGetXXX` function calls. If algebraic equations occur it is most simple to utilize a DAE (Differential-Algebraic-Equation) integrator. Otherwise, also an ODE (Ordinary-Differential-Equation) integrator can be used, provided an additional algebraic equation solver is used to compute the unknowns of the algebraic equation systems.

The different variants are sketched at hand of the example from Figure 7. For all variants, first the structure of the equations have to be formulated that describe the connection structure, using the information from “directDependency” in “ScalarVariable”. This is a special case of the technique of object-oriented modelling, see, e.g., *Elmqvist (1978)*, or *Otter (1999)*. For the example from Figure 7, the equation structure can be defined as (e.g. the first equation states, that the output `y1` of A can be computed from the inputs `u1` and `u2` from A, and from the states of A. The latter information is not explicitly visible, since it is irrelevant for the sorting procedure):

```
// Component equations
A.y1 = fA1(A.u1, A.u2)
B.y1 = fB1(B.u2)
B.y2 = fB2(B.u2)
C.y1 = fC1(C.u1)
C.y2 = fC2(C.u1)

// Connection equations
A.u1 = C.y1
A.u2 = B.y1
B.u1 = A.y1
B.u2 = C.y2
C.u1 = B.y2
```

This set of equations can be directly formulated as a DAE consisting of the state derivative equations of A, B, C and of five additional algebraic equations (= connection equations formulated in residue form, such as “`residue1 = A.u1 - C.y1`” and using all inputs as algebraic unknowns of the DAE).

It is also possible to reduce the dimension of the algebraic equation system to arrive at a DAE of a smaller dimension, or to use an ODE solver. This requires to sort the structural equations above. This can be

performed with the algorithms as used in object-oriented modelling. Especially, “BLT” (Block-Lower-Triangular) transformation can be used to sort the equations and “Tearing” can be used to reduce the dimensions of the remaining algebraic equation systems. The details of these algorithms can be found, e.g., in *Elmqvist (1978)*, section 5.2, or *Otter (1999)*. A third alternative is to not support algebraic equations of connected FMUs and use a pure ODE solver. In the latter case it is sufficient to use the “strongConnect” algorithm of Tarjan⁷, see *Tarjan (1972)* or *Elmqvist (1978)*. Using BLT on the example above results in:

```
// Algebraic system of equations (unknowns: B.u2, C.u1)
B.y2 := fB2(B.u2)
C.y2 := fC2(C.u1)
residue1 = B.u2 - C.y2
residue2 = C.u1 - B.y2

// Sequence of equations
B.u2 := C.y2
B.y1 := fB1(B.u2)
C.y1 := fC1(C.u1)
A.u1 := C.y1
A.u2 := B.y1
A.y1 := fA1(A.u1, A.u2);
```

The size of the algebraic system can be further reduced by tearing leading to:

```
// Tearing algebraic system of equations (unknowns: B.u2)
B.y2 := fB2(B.u2)
C.u1 := B.y2
C.y2 := fC2(C.u1)
residue1 = B.u2 - C.y2
```

As a result, this example can be formulated as a DAE consisting of the state derivative equations of A, B, C and of one additional algebraic equation. Alternatively, an ODE integrator can be used to solve the equations. This requires to solve an algebraic equation system with a non-linear algebraic equation solver whenever the derivatives have to be computed. The latter approach can be implemented in the following way (the integrator provides all states and the model has to compute the state derivatives):

```
// Set actual time instant
fmiSetTime( < of A > );
fmiSetTime( < of B > );
fmiSetTime( < of C > );

// Set continuous states of all components (provided by integrator)
fmiSetContinuousStates( < of A > );
fmiSetContinuousStates( < of B > );
fmiSetContinuousStates( < of C > );

// Solve algebraic system of equations
// input: B.u2, output: residue1
< start of non-linear algebraic solver >
fmiSetReal( < B.u2 > )
fmiGetReal( < B.y2 > )
fmiSetReal( < C.u1 = B.y2 > )
fmiGetReal( < C.y2 > )
```

⁷ Since only input/output blocks are here connected together, the first part of BLT to find an assignment for every variable is trivial: All left hand side variables of the component and connection equations are the assigned variables. Then, a directed graph is constructed with all input and output variables as nodes and the structural dependencies as edges. With function strongConnect(..) of Tarjan (1972), it can be detected that no loops are present and the evaluation sequence is determined.

```
    residuel = B.u2 - C.y2
< end of non-linear algebraic solver >

// Compute the remaining inputs and outputs of all components
fmiGetReal( < B.y1 > )
fmiGetReal( < C.y1 > )
fmiSetReal( < A.u1 = C.y1 > )
fmiSetReal( < A.u2 = B.y1 > )
fmiGetReal( < A.y1 > )

// Compute the state derivatives of all components (provide to integrator)
fmiGetDerivatives( < of A > )
fmiGetDerivatives( < of B > )
fmiGetDerivatives( < of C > )
```

It is of course also possible to connect FMUs together with acausal components and not only to input/output blocks. The above scheme does not change in this case. An important application is to import an FMU in to a Modelica model, see *Modelica (2009)*. Since a Modelica simulation environment has all necessary algorithms for connecting acausal and causal components together, the FMUs must only be appropriately interfaced. One simple way is to generate a Modelica wrapper model using the information available in the xml-file of the corresponding FMU (note, this technique can be generally applied for most simulation environments).

Appendix C Features for Future Versions

In this appendix, features are summarized that are already known to be missing and might be added in a future release.

Improved initialization

The `fmiInitialize` function can currently only be called once for one instance. It might be necessary to improve this, in order to better handle algebraic loops between connected FMUs. Note, even if `fmiInitialize` can only be called once, an event can be triggered and then event iteration via `fmiEventUpdate` is possible at the initial time.

Better handling of time events

Time events should be defined with an absolute precision. This requires to introduce "time" as integer variable. The (absolute) time resolution for a simulation model is specified globally. Time can only advance in steps of the time resolution. A submodel may have a different (absolute) time resolution (e.g. a controller running on a particular micro-processor). Furthermore, improved support for periodically sampled systems is needed to enhance efficiency.

Dense and sparse Jacobian

An analytic or approximate analytic Jacobian might be directly computed with a new function. Dense and sparse Jacobians must be supported. Optionally, also only the structure of the Jacobian might be reported (and the simulation environment computes the Jacobian numerically, but taking into account the zero/non-zero pattern).

Saving and restoring a model state

It should be possible to stop a simulation, save the model state and restart the simulation exactly at the place where the simulation was stopped. The interface could be defined in the following way:

Additions to `fmiModelTypes.h`:

```
typedef char fmiByte; // byte data type
```

Additions to `fmiModelFunctions.h`:

```
fmiStatus = fmiGetModelStateDimension(fmiComponent c, size_t *nModelState);  
fmiStatus = fmiGetModelState(fmiComponent c, fmiByte modelState[], size_t nModelState);
```

`fmiGetModelState` returns the complete state of model "c", in order that the complete internal data structure of "c" can be reconstructed. "modelState" is a byte vector of length "nModelState". This vector must be allocated by the calling environment before `fmiGetModelState` is called. In order that this is possible `fmiGetModelStateDimension` returns the needed length of the vector.

```
fmiStatus = fmiSetModelState(fmiComponent c, fmiByte modelState[], nModelState);
```

The current model "c" is replaced by a previous state defined by byte vector "modelState".

"modelState" must be the vector returned by a previous call to `fmiGetModelState` of exactly the same model. After calling `fmiSetModelState`, the model is in state "stepAccepted".

There are open issues: `fmiGetModelState` should only be callable directly after an event (it might be a step event), in order that restarting the integration is a standard operation (restart after an event). Otherwise,

the integrator might be in an inconsistent state. Most likely restrictions are needed, in order that restarting a model is possible, e.g., restarting is not possible, if a model accesses external resources, like files or communication channels. In the xml-file it could be defined, whether it is allowed to “safe the model state” or whether this is not possible.

Changing dimension of state vector and of event indicator vector

Submodels in a system might be enabled or disabled. To handle this efficiently, the states of the disabled components should not be integrated. This could be achieved by defining a maximum dimension of the state vector “nx_max” and of the event indicators “nz_max” in the Model Description File. An actual dimension (nx,nz) is determined during initialization and at events ($nx \leq nx_max$, $nz \leq nz_max$). Since the Model Exchange functions copy the return values from its internal data structure to the interface, it is not much burden to change this copy operation ones less or more values must be copied. Therefore, two additional return arguments (nx, nz) might be provided for initialization and for eventUpdate.

Special handling of multi-body systems

SIMPACK has the feature that the generated code may contain both the model with integrators (using the specialized handling of large multi-body systems) and the model without integrators. The benefit is that the user can easily switch between both representation forms according to his needs. Furthermore, multi-body programs are usually DAEs with a very special structure and this structure might be revealed in the interface to allow an efficient solution.

Online changeable parameters for real-time training simulators

Parameters are constant although, it would be useful to change them online, e.g., for real-time training simulators, or for quickly tuning parameters in offline simulation. From a mathematical point of view, changing a parameter has to be seen as a short-hand notation to stop the simulation and initialize a new simulation run with the previous internal model state where the desired parameters are changed.

Map variable hierarchy to xml file

The current Model Description File can only handle scalar variables. This means that a lot of definitions must be repeated if, e.g., an array is mapped to a set of scalars. The xml file should be enhanced, so that, e.g., array and record structures are maintained. A handle of a variable might be computed from a new function, that gets the handle of the array and the desired indices. The benefit is that the xml-file becomes much smaller if large variable arrays are present.

DAE representation

Models could be optionally described by DAEs with index 1 or 2. The benefit is that larger systems can be handled because systems of equations are only solved once and not twice (with an ODE description, equation systems might be solved inside the ODE description, and a stiff solver will additionally solve equation systems in the integrator), and the sparsity of the Jacobian might be larger.

Nested FMUs with several model zip-files

In the current version, nested FMUs are stored in one zip-file and the hierarchical FMU structuring is not exposed. This should be improved, e.g., so that every FMU is distributed in its own model zip-file which is referenced in other FMUs.



Support for Optimization

In order to improve optimization (parameter as well as trajectory optimization), it is useful to get more information from a model, instead of constructing this information from the available interfaces via purely numerical methods. For example, it would be useful to provide a function to get the partial derivatives of the state derivatives with respect to selected parameters.

Appendix D Glossary

This glossary is a subset of (*MODELISAR Glossary, 2009*) with some extensions specific to this document.

Term	Description
<i>AUTOSAR</i>	AUTomotive Open System Architecture (www.autosar.org). Evolving standard of the automotive industry to define the implementation of embedded systems in vehicles including communication mechanisms. An important part is the standardization of C-functions and macros to communicate between software components. AUTOSAR is targeted to built on top of the real-time operating system OSEK (www.osek-vdx.org , de.wikipedia.org/wiki/OSEK). The use of the AUTOSAR standard requires AUTOSAR membership.
<i>co-simulation</i>	Couple several simulation programs including their numerical solvers in order to simulate a system consisting of several subsystems.
<i>ECU</i>	Electronic Control Unit (Microprocessor that is used to control a sub-system in a vehicle)
<i>event</i>	The time instant at which the integration is halted and variables may change their values discontinuously. Between event instants, all variables are continuous.
<i>FMI</i>	Functional Mock-up Interface: Interface of a functional mock-up in form of a model. In analogy to the term digital mock-up (see <i>mock-up</i>), functional mock-up describes a computer-based representation of the functional behaviour of a system for all kinds of analyses.
<i>FMU</i>	Functional Mock-up Unit: A “model class” from which one or more “model instances” can be build for simulation. A FMU is stored in one zip-file as defined in section 4 consisting basically of one xml file (see section 3) that defines the model variables and a set of C-functions (see section 2), in source or binary form, to execute the model equations.
<i>mock-up</i>	A full-sized structural, but not necessarily functional model built accurately to scale, used chiefly for study, testing, or display. In the context of computer aided design (CAD), a digital mock-up (DMU) means a computer-based representation of the product geometry with its parts, usually in 3-D, for all kinds of geometrical and mechanical analyses.
<i>model</i>	A model is a mathematical or logical representation of a system of entities, phenomena, or processes. Basically a model is a simplified abstract view of the complex reality. It can be used to compute its expected behaviour under specified conditions. In this document, “models” are described by differential, algebraic and discrete equations and are mainly used to represent physical systems and controllers.
<i>Model Description Schema</i>	An XML schema that defines how all relevant, non-executable, information about a “model class” (<i>FMU</i>) is stored in a text file in XML format. Most important, data for every variable is defined (variable name, handle, data type, variability, unit, etc.), see section 3.
<i>Model Interface</i>	A set of C-interface definitions to access the equations of a dynamic system from an external program, e.g., to compute the state derivatives of a model, see section 2.

Term	Description
<i>parameter</i>	A quantity within a <i>model</i> , which remains constant during simulation, but may be changed before a simulation is started. Examples: mass, stiffness, resistance, etc.
<i>state</i>	The “continuous states” of a model are all variables that appear differentiated in the model and are independent from each other. The “discrete states” of a model are time-discrete variables that have two values in a model: The value of the variable from the previous <i>event</i> instant, and the value of the variable at the actual event instant.
<i>state event</i>	<i>Event</i> that is defined by the time instant where the domain $z > 0$ of an event indicator variable z is changed to $z \leq 0$, or vice versa. This definition is slightly different as the usual standard definition of state events: “ $z(t)z(t_{i-1}) \leq 0$ ” which has the severe drawback that the value of the event indicator at the previous event instant, $z(t_{i-1}) \neq 0$, must be non-zero and this condition cannot be guaranteed. The often used term “zero crossing function” for z is misleading (and is therefore not used in this document), since a state event is defined by a change of a domain and not by a zero crossing of a variable.
<i>step event</i>	<i>Event</i> that might occur at a completed integrator step. Since this event type is not defined by a precise time or condition, it is usually not defined by a user. A program may use it, e.g., to dynamically switch between different states (see Figure 6 in Appendix B.3). A step event is handled much more efficiently than a <i>state event</i> , because the event is just triggered after performing a check at a completed integrator step, whereas a search procedure is needed for a state event.
<i>time event</i>	<i>Event</i> that is defined by a predefined time instant. Since the time instant is known in advance, the integrator can select its step size so that the event point is directly reached. Therefore, this event can be handled efficiently.
<i>XML</i>	eXtensible Markup Language (www.w3.org/XML , en.wikipedia.org/wiki/XML) – An open standard to store information on text files in a structured form.